

# Pendant & Reel Cable and Accessories

LAPP products are available from

## MARYLAND METRICS

P.O. Box 261 Owings Mills, MD 21117 USA

ph:(410)358-3130 (800)638-1830

fx:(410)358-3142 (800)872-9329

RFQ form: <http://mdmetric.com/rfq.htm>













Lapp Index Page: <http://mdmetric.com/elect/contents.htm>

<sup>®</sup>  
OLFLEX

11



# Pendant & Reel Cable and Accessories

<b>OLFLEX® SPIRAL 400 P</b> (Formerly SPIREX® 400 P) Retractable Control Cable with Polyurethane Jacket		<b>219</b>
<b>OLFLEX® SPIRAL 540 P</b> (Formerly SPIREX® 540 P) Retractable Power Supply Cable with a Safety Yellow Polyurethane Jacket		<b>221</b>
<b>OLFLEX® SPIRAL H07RN-F</b> (Formerly SPIREX® H07RN-F) Retractable Power Supply Cable with Neoprene Jacket		<b>223</b>
<b>UNITRONIC® SPIRAL</b> (Formerly SPIREX® Data Spiral Cable) Retractable Shielded Data Cable with Polyurethane Jacket		<b>224</b>
<b>OLFLEX® Special Design Coil Cords</b>		<b>226</b>
<b>OLFLEX® CRANE (N)SHTÖU</b> (Formerly KRANFLEX® NSHTÖU) Neoprene Pendant & Reel Cable		<b>227</b>
<b>OLFLEX® CRANE VS NSHTÖU</b> (Formerly KRANFLEX® VS NSHTÖU) Neoprene Pendant & Reel Cable for Applications Exposed to High Mechanical Stress		<b>228</b>
<b>Pendant and Reel Cable Installation Instructions</b>		<b>229</b>
<b>OLFLEX® CRANE PUR</b> Reduced Diameter Pendant and Reel Cable		<b>230</b>
<b>OLFLEX® CRANE</b> (Formerly NEOFLEX® ROUND) All Weather Neoprene Pendant Control Cable		<b>231</b>
<b>OLFLEX® FLAT</b> UL/CSA Approved Flat Festoon Cable (PVC)		<b>233</b>
<b>OLFLEX® LIFT F</b> Flat Festoon Cable		<b>234</b>
<b>OLFLEX® CRANE 2S</b> (Formerly OLFLEX® TRAGO 2S) Pendant Cable with Two Steel Supporting Elements		<b>235</b>
<b>OLFLEX® CRANE F</b> (Formerly NEOFLEX® FLAT CABLE) Flat Festoon Cable (Neoprene)		<b>236</b>
<b>SVF &amp; SVF-K Series Cable Connectors</b> Compact Strain Relief Connectors for Flat and Festoon Cable Plastic and Brass		<b>237</b>

# OLFLEX® SPIRAL 400 P



(Formerly SPIREX® 400 P)

Retractable Control Cable with Polyurethane Jacket

OLFLEX® SPIRAL 400 P is a multi-conductor, retractable control cable with a rugged abrasion resistant polyurethane jacket and an extension capability of up to 3 times its retracted length.

Recommended Applications:

Machine tool manufacturing, Cranes and Hoists.

Application Advantage:





- Excellent resistance to mineral oils and cutting fluids
- Highly resistant to mechanical abuse typically found in machine tools, cranes and hoists

## OLFLEX® SPIRAL 400 P Construction: (OLFLEX® 400 P)

Finely stranded bare copper conductors; PVC insulation; conductors cabled together with non-wicking fillers; dry lubricant; specially formulated gray polyurethane jacket.





- Length of tails 8 in./200 mm and 24 in./600 mm
- Tail type- Tangent
- Special designs available, see Page 226

Cable Attributes, See Page 653			
	Oil Resistance: OR-05		Flame Resistance: FR-02
	Motion Type: FL-01		Mechanical Properties: MP-05

Complete the installation with:			
	SKINTOP® Strain Relief: Page 486		EPIC® Connectors: Page 251
	OLFLEX® Tubing: Page 546		SKINTOP® FLEX: Page 492

## Technical Data:

	Temperature Range:	+5°C to +50°C		Conductor Stranding:	Fine wire per VDE 0295, Class 5
	Working Voltage:	300/500V		Color Code:	Black with white numbers, plus green/yellow ground
	Test Voltage:	3000V			

# OLFLEX® SPIRAL 400 P



(Formerly SPIREX® 400 P)

Retractable Control Cable with Polyurethane Jacket

Part Number	Number of Conductors includes ground	Nominal Outer Diameter		Spiral Length				Copper Weight lbs/ft	Nominal Spiral Outer Diameter	
		inches	mm	Extended inches	Extended mm	Retracted inches	Retracted mm		inches	mm
<b>18 AWG (24/32) 1.00 mm<sup>2</sup></b>										
70002646	2	.224	5.7	59	1500	20	500	63	.906	23
70002647	2	.224	5.7	118	3000	40	1000	112	.906	23
70002648	2	.224	5.7	177	4500	60	1500	161	.906	23
70002649	2	.224	5.7	236	6000	80	2000	210	.906	23
70002651	3	.236	6.0	59	1500	20	500	89	.905	23
70002652	3	.236	6.0	118	3000	40	100	159	.905	23
70002653	3	.236	6.0	177	4500	60	1500	229	.905	23
70002654	3	.236	6.0	236	6000	80	2000	299	.905	23
70002656	4	.256	6.5	59	1500	20	500	129	1.142	29
70002657	4	.256	6.5	118	3000	40	1000	235	1.142	29
70002658	4	.256	6.5	177	4500	60	1500	338	1.142	29
70002659	4	.256	6.5	236	6000	80	2000	441	1.142	29
70002661	5	.280	7.1	59	1500	20	500	158	1.181	30
70002662	5	.280	7.1	118	3000	40	1000	281	1.181	30
70002663	5	.280	7.1	177	4500	60	1500	403	1.181	30
70002664	5	.280	7.1	236	6000	80	2000	526	1.181	30
70002666	7	.315	8.0	49	1250	20	500	234	1.220	31
70002667	7	.315	8.0	98	2500	40	1000	420	1.220	31
70002668	7	.315	8.0	147	3750	60	1500	569	1.220	31
70002669	7	.315	8.0	196	5000	80	2000	792	1.220	31
<b>16 AWG (30/30) 1.50 mm<sup>2</sup></b>										
70002681	2	.248	6.3	59	1500	20	500	99	1.142	29
70002682	2	.248	6.3	118	3000	40	1000	179	1.142	29
70002683	2	.248	6.3	177	4500	60	1500	259	1.142	29
70002684	2	.248	6.3	236	6000	80	2000	339	1.142	29
70002687	3	.264	6.7	59	1500	20	500	144	1.181	30
70002688	3	.264	6.7	118	3000	40	1000	257	1.181	30
70002689	3	.264	6.7	177	4500	60	1500	373	1.181	30
70002690	3	.264	6.7	236	6000	80	2000	485	1.181	30
70002699	5	.319	8.1	49	1250	20	500	236	1.299	33
70002700	5	.319	8.1	98	2500	40	1000	426	1.299	33
70002701	5	.319	8.1	147	3750	60	1500	605	1.299	33
70002702	5	.319	8.1	196	5000	80	2000	790	1.299	33
70002705	7	.350	8.9	49	1250	20	500	326	1.496	38
70002706	7	.350	8.9	98	2500	40	1000	577	1.496	38
70002707	7	.350	8.9	147	3750	60	1500	835	1.496	38
70002708	7	.350	8.9	196	5000	80	2000	1086	1.496	38
<b>14 AWG (50/30) 2.50 mm<sup>2</sup></b>										
70002716	3	.319	8.1	49	1250	20	500	242	1.496	38
70002717	3	.319	8.1	98	2500	40	1000	431	1.496	38
70002718	3	.319	8.1	147	3750	60	1500	619	1.496	38
70002719	3	.319	8.1	196	5000	80	2000	813	1.496	38
70002721	5	.394	10.0	49	1250	20	500	419	1.929	49
70002722	5	.394	10.0	98	2500	40	1000	766	1.929	49
70002723	5	.394	10.0	147	3750	60	1500	1105	1.929	49
70002724	5	.394	10.0	196	5000	80	2000	1435	1.929	49

# OLFLEX® SPIRAL 540 P



(Formerly SPIREX® 540 P)

Retractable Power Supply Cable with a Safety Yellow Polyurethane Jacket

OLFLEX® SPIRAL 540 P is a multi-conductor, elastomeric alloy insulated, retractable power supply cable with a yellow polyurethane outer jacket. May be used both indoors and outdoors, in wet, dry or hot conditions. The cable has an extension capability of 3 times its retracted length.

**Application Advantage:**

- High visibility safety yellow jacket
- Abrasion and cut resistant jacket
- Highly resistant to oils and low temperature

**Recommended Applications:**

Power supply for Machine tools, Hand tools, Cranes and Hoists.



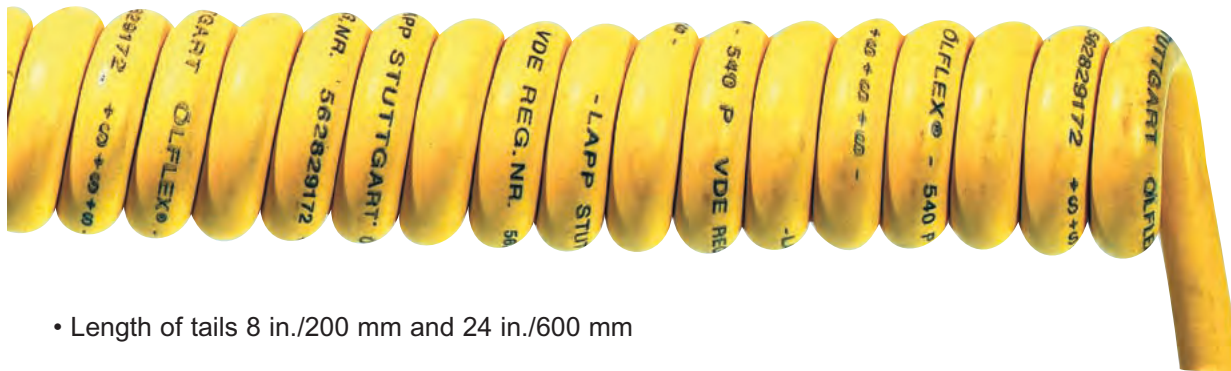

## OLFLEX® SPIRAL 540 P Construction: (OLFLEX® 540 P)

Finely stranded bare copper conductors; TPE insulation; conductors cabled with non-wicking fillers; dry lubricant; flame retardant yellow polyurethane jacket.



- Length of tails 8 in./200 mm and 24 in./600 mm
- Tail type- Tangent
- Special designs available, see Page 226







**Cable Attributes, See Page 653**

	Oil Resistance: OR-05		Flame Resistance: FR-02
	Motion Type: FL-01		Mechanical Properties: MP-05

**Complete the installation with:**

	SKINTOP® Strain Relief: Page 486		EPIC® Connectors: Page 251
	OLFLEX® Tubing: Page 546		SKINTOP® FLEX: Page 492

## Technical Data:

	Temperature Range:	-30°C to +50°C		Conductor Stranding:	Fine wire per VDE 0295, Class 5
	Rated Voltage:	300/500V (18 AWG) 450/750V (16-14 AWG)		Color Code:	VDE 0293, Chart 6, Page 673
	Test Voltage:	3000V		Approvals:	VDE Reg. No. 6583 - 300/500V VDE Reg. No. 6584 - 450/750V

# OLFLEX® SPIRAL 540 P

(Formerly SPIREX® 540 P)

Retractable Power Supply Cable with a Safety Yellow Polyurethane Jacket



Part Number	Number of Conductors includes ground	Nominal Outer Diameter		Spiral Length				Copper Weight lbs/mft	Nominal Spiral Outer Diameter	
		inches	mm	Extended inches	Extended mm	Retracted inches	Retracted mm		inches	mm
<b>18 AWG (32/32) 1.00 mm<sup>2</sup></b>										
73220123	2	.276	7.0	40	1000	12	300	41	.945	24
73220124	2	.276	7.0	80	2000	24	600	68	.945	24
73220125	2	.276	7.0	138	3500	39	1000	115	.945	24
73220126	2	.276	7.0	197	5000	59	1500	151	.945	24
73220127	3	.291	7.4	40	1000	12	300	72	1.142	29
73220128	3	.291	7.4	80	2000	24	600	123	1.142	29
73220129	3	.291	7.4	138	3500	39	1000	191	1.142	29
73220130	3	.291	7.4	197	5000	59	1500	276	1.142	29
71220131	4	.323	8.2	40	1000	12	300	94	1.181	30
71220132	4	.323	8.2	80	2000	24	600	155	1.181	30
71220133	4	.323	8.2	138	3500	39	1000	240	1.181	30
71220134	4	.323	8.2	197	5000	59	1500	346	1.181	30
71220135	5	.354	9.0	40	1000	12	300	108	1.260	32
71220136	5	.354	9.0	80	2000	24	600	181	1.260	32
71220137	5	.354	9.0	138	3500	39	1000	310	1.260	32
71220138	5	.354	9.0	197	5000	59	1500	406	1.260	32
73220139	7	.429	10.9	40	1000	14	350	180	1.575	40
73220140	7	.429	10.9	80	2000	28	700	310	1.575	40
73220141	7	.429	10.9	138	3500	47	1200	497	1.575	40
73220142	7	.429	10.9	197	5000	67	1700	684	1.575	40
<b>16 AWG (30/30) 1.50 mm<sup>2</sup></b>										
73220143	2	.331	8.4	40	1000	12	300	67	1.220	31
73220144	2	.331	8.4	80	2000	24	600	114	1.220	31
73220145	2	.331	8.4	138	3500	39	1000	180	1.220	31
73220146	2	.331	8.4	197	5000	59	1500	254	1.220	31
73220147	3	.350	8.9	40	1000	12	300	98	1.260	32
73220148	3	.350	8.9	80	2000	24	600	164	1.260	32
73220149	3	.350	8.9	138	3500	39	1000	254	1.260	32
73220150	3	.350	8.9	197	5000	59	1500	366	1.260	32
71220151	5	.429	10.9	40	1000	14	350	189	1.575	40
71220152	5	.429	10.9	80	2000	28	700	327	1.575	40
71220153	5	.429	10.9	138	3500	47	1200	523	1.575	40
71220154	5	.429	10.9	197	5000	67	1700	720	1.575	40
73220155	7	.531	13.5	40	1000	14	350	278	2.047	52
73220156	7	.531	13.5	80	2000	28	700	483	2.047	52
73220157	7	.531	13.5	138	3500	47	1200	775	2.047	52
73220158	7	.531	13.5	197	5000	67	1700	1068	2.047	52
<b>14 AWG (50/30) 2.50 mm<sup>2</sup></b>										
73220159	3	.417	10.6	40	1000	14	350	192	1.575	40
73220160	3	.417	10.6	80	2000	28	700	331	1.575	40
73220161	3	.417	10.6	138	3500	47	1200	531	1.575	40
73220162	3	.417	10.6	197	5000	67	1700	732	1.575	40
71220163	5	.528	13.4	40	1000	14	350	335	2.008	51
71220164	5	.528	13.4	80	2000	28	700	583	2.008	51
71220165	5	.528	13.4	138	3500	47	1200	937	2.008	51
71220166	5	.528	13.4	197	5000	67	1700	1291	2.008	51

# OLFLEX® SPIRAL H07RN-F



(Formerly SPIREX® H07RN-F)

Retractable Power Supply Cable with Neoprene Jacket

OLFLEX® SPIRAL H07RN-F is a multi-conductor, rubber insulated, retractable power supply cable with a rugged, black neoprene jacket. This cable can be used both indoors and outdoors, in wet or dry conditions. The cable has an extension capability of up to 3 times the retracted length.

**Recommended Applications:**

Power supply for Machine tools, Hand tools, Car wash equipment, Cranes and Hoists.

**Application Advantage:**

- Resistant to most oils, greases and chemicals
- Weather resistant
- Resistant to mechanical stresses

**OLFLEX® SPIRAL H07RN-F Construction:**

Finely stranded bare copper conductors; synthetic rubber insulation; dry lubricant; black neoprene jacket.



- Length of tails 20 in/ 500mm.
- Tail Type- Tangent

**Cable Attributes, See Page 653**

	Oil Resistance: OR-01		Flame Resistance: FR-01
	Motion Type: FL-01		Mechanical Properties: MP-01

**Complete the installation with:**

	SKINTOP® Strain Relief: Page 486		EPIC® Connectors: Page 251
	OLFLEX® Tubing: Page 546		SKINTOP® FLEX: Page 492

**Technical Data:**

Temperature Range:	-25°C to +60°C	Conductor Stranding:	Fine wire per VDE 0295, Class 5
Rated Voltage:	450/750V	Color Code:	VDE 0293-308, Chart 6, Page 673
Test Voltage:	2500V	Approvals:	Based on VDE 0282

Part Number	Number of Conductors includes ground	Nominal Outer Diameter		Nominal Spiral Outer Diameter		Spiral Length				Copper Weight lbs/mft
		inches	mm	inches	mm	Extended inches	mm	Retracted inches	mm	
16 AWG (30/30) 1.50 mm <sup>2</sup>										
73010000	3	.398	10.1	1.299	33	59	1500	20	500	146
73010010	3	.398	10.1	1.299	33	118	3000	40	1000	260
73010020	3	.398	10.1	1.299	33	177	4500	59	1500	373
73010030	3	.398	10.1	1.299	33	236	6000	79	2000	487
71010100	4	.437	11.1	1.378	35	59	1500	20	500	187
71010110	4	.437	11.1	1.378	35	118	3000	40	1000	331
71010120	4	.437	11.1	1.378	35	177	4500	59	1500	473
71010130	4	.437	11.1	1.378	35	236	6000	79	2000	618
71010200	5	.484	12.3	1.575	40	59	1500	20	500	235
71010210	5	.484	12.3	1.575	40	118	3000	40	1000	412
71010220	5	.484	12.3	1.575	40	177	4500	59	1500	599
71010230	5	.484	12.3	1.575	40	236	6000	79	2000	779
73010400	7	.583	14.8	1.811	46	59	1500	20	500	323
73010410	7	.583	14.8	1.811	46	118	3000	40	1000	581
73010420	7	.583	14.8	1.811	46	177	4500	59	1500	827
73010430	7	.583	14.8	1.811	46	236	6000	79	2000	1076

# UNITRONIC® SPIRAL



(Formerly SPIREX® Data Spiral Cable)

Retractable Shielded Data Cable with Polyurethane Jacket

UNITRONIC® SPIRAL is a shielded, multi-conductor signal and data cable designed to extend 4 times the retracted length.

### Recommended Applications:

For use with computers, Data transmission, Office equipment, Process control and Instrumentation applications.

### Application Advantage:

- Overall screening prevents interference and guarantees accurate pulse transmission
- Highly flexible for ease of use
- For use in confined areas where installation is tight.

### UNITRONIC® SPIRAL Construction:

Finely stranded bare copper conductors; PVC insulation; conductors cabled together with non-wicking fillers; dry lubricant; overall copper spiral shield, specially formulated black polyurethane jacket.



- Length of tails 8 in./200 mm and 24 in./600 mm
- Tail type- Tangent

### Cable Attributes, See Page 653



Oil Resistance:  
OR-05



Flame  
Resistance:  
FR-02



Motion Type:  
FL-01



Mechanical  
Properties:  
MP-02

### Complete the installation with:



SKINTOP®  
Strain Relief:  
Page 486



EPIC®  
Connectors:  
Page 251



OLFLEX®  
Tubing:  
Page 546



SKINTOP®  
FLEX:  
Page 492

### Technical Data:

Temperature Range: -5°C to +50°C

Working Voltage: 350V

Test Voltage: 1200V

Conductor Stranding: Super fine wire per VDE 0295, Class 6

Color Code: DIN 47100, Chart 8, Page 674

Approvals: Based on VDE specifications

# UNITRONIC® SPIRAL



(Formerly SPIREX® Data Spiral Cable)

Retractable Shielded Data Cable with Polyurethane Jacket

Part Number	Number of Conductors includes ground	Nominal Outer Diameter		Nominal Spiral Outer Diameter		Spiral Length				Copper Weight lbs/mft
		inches	mm	inches	mm	Extended inches	Extended mm	Retracted inches	Retracted mm	
26 AWG (18/38) 0.14 mm <sup>2</sup>										
73220200	2	.157	4.0	.591	15	16	400	4	100	11
73220201	2	.157	4.0	.591	15	31	800	8	200	16
73220202	2	.157	4.0	.591	15	47	1200	12	300	21
73220203	2	.157	4.0	.591	15	63	1600	16	400	25
73220204	2	.157	4.0	.591	15	79	2000	20	500	31
73220205	3	.165	4.2	.709	18	16	400	4	100	13
73220206	3	.165	4.2	.709	18	31	800	8	200	22
73220207	3	.165	4.2	.709	18	47	1200	12	300	28
73220208	3	.165	4.2	.709	18	63	1600	16	400	35
73220209	3	.165	4.2	.709	18	79	2000	20	500	42
73220210	4	.173	4.4	.748	19	16	400	4	100	15
73220211	4	.173	4.4	.748	19	31	800	8	200	23
73220212	4	.173	4.4	.748	19	47	1200	12	300	31
73220213	4	.173	4.4	.748	19	63	1600	16	400	39
73220214	4	.173	4.4	.748	19	79	2000	20	500	48
73220215	5	.201	5.1	.787	20	16	400	4	100	17
73220216	5	.201	5.1	.787	20	31	800	8	200	27
73220217	5	.201	5.1	.787	20	47	1200	12	300	36
73220218	5	.201	5.1	.787	20	63	1600	16	400	45
73220219	5	.201	5.1	.787	20	79	2000	20	500	53
73220220	6	.213	5.4	.827	21	16	400	4	100	21
73220221	6	.213	5.4	.827	21	31	800	8	200	31
73220222	6	.213	5.4	.827	21	47	1200	12	300	42
73220223	6	.213	5.4	.827	21	63	1600	16	400	52
73220224	6	.213	5.4	.827	21	79	2000	20	500	63
73220225	7	.213	5.4	.827	21	16	400	4	100	22
73220226	7	.213	5.4	.827	21	31	800	8	200	33
73220227	7	.213	5.4	.827	21	47	1200	12	300	44
73220228	7	.213	5.4	.827	21	63	1600	16	400	55
73220229	7	.213	5.4	.827	21	79	2000	20	500	66
73220230	12	.276	7.0	1.063	27	16	400	4	100	42
73220231	12	.276	7.0	1.063	27	31	800	8	200	64
73220232	12	.276	7.0	1.063	27	47	1200	12	300	86
73220233	12	.276	7.0	1.063	27	63	1600	16	400	108
73220234	12	.276	7.0	1.063	27	79	2000	20	500	130
73220235	18	.307	7.8	1.142	27	16	400	4	100	49
73220236	18	.307	7.8	1.142	27	31	800	8	200	80
73220237	18	.307	7.8	1.142	27	47	1200	12	300	107
73220238	18	.307	7.8	1.142	27	63	1600	16	400	134
73220239	18	.307	7.8	1.142	27	79	2000	20	500	160

# OLFLEX® Special Design Coil Cords

Non-Standard Quotation Inquiry

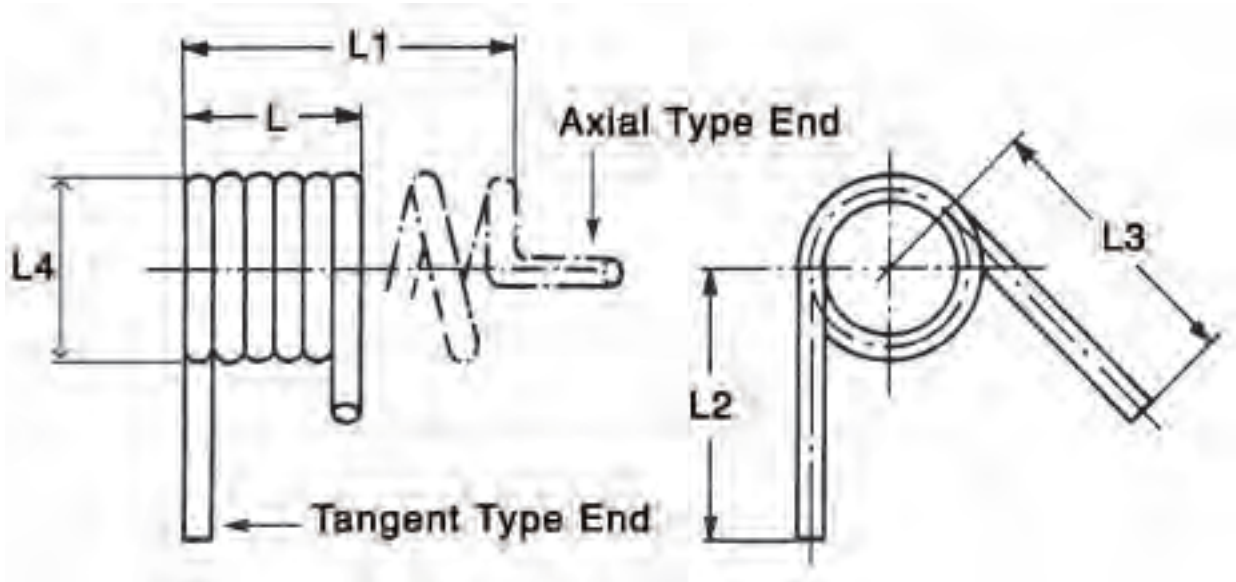

Cable Type:    400 P     490 P     540 P     590 P

Cable Part No.

Description:

Retracted Length (L) in.

Extended Length (L1) in.

Tail Lengths (L2) in. (L3)

Tail Type:    Tangent     Axial

Spiral Outer Diameter (L4)

No. of Pieces

# OLFLEX® CRANE NSHTÖU



(Formerly KRANFLEX® NSHTÖU)  
Neoprene Pendant and Reel Cable

OLFLEX® CRANE NSHTÖU pendant and reel cable is constructed with a reinforced neoprene jacket and is designed for use wherever cable operation requires frequent reeling and unreeling on pulleys, drums or rollers under tensile load. Suitable for use indoors or outdoors in wet or dry conditions.

**Recommended Applications:**

Suitable use on Hoisting gear, Pendants and Material handling equipment

**Application Advantage:**

- Rugged jacket resistant to mechanical abuse and chemicals
- Weather resistant black polychloroprene jacket
- Designed for crucial bending radius
- Reinforced jacket for added strength

**OLFLEX® CRANE NSHTÖU Construction:**

Stranded copper conductors; rubber insulation; dry lubricant; non-wicking tape; reinforced black neoprene jacket.



**Cable Attributes, See Page 653**

	Oil Resistance: OR-01		Flame Resistance: FR-01
	Motion Type: FL-01		Mechanical Properties: MP-05

**Availability:**

Standard put-ups are 164ft, 328ft, 1640ft, and 3280ft. Bulk reels can be cut to length.

**Complete the installation with:**

	SKINTOP® Strain Relief: Page 486		EPIC® Connectors: Page 251
	OLFLEX® Tubing: Page 546		SKINTOP® MS-M Page 502

**Technical Data:**

- |  |                         |   |  |                      |  |
|--|-------------------------|---|--|----------------------|--|
|  | Minimum Bending Radius: | See Installation Instructions                               |  | Conductor Stranding: | Fine wire per VDE 0295, Class 5 IEC 60228 Cl.5   |
|  | Temperature Range:      | - for flexing: 0°C to +80°C<br>- for static: -45°C to +80°C |  | Color Code:          | - up to 5 conductors- VDE 0293-308, Chart 6, Page 673<br>- 6 or more conductors- Black with white numbers plus a green/yellow ground |
|  | Rated Voltage:          | 600/1000V   |  | Approvals:           | VDE 0298 Part 4  |
|  | Test Voltage:           | 3000V   |  |                      |  |

Part Number	Number of Conductors includes ground	Nominal Outer Diameter inches	mm	Copper Weight lbs/mft	kg/m	Approx. Weight lbs/mft	kg/m	Part Number	Number of Conductors includes ground	Nominal Outer Diameter inches	mm	Copper Weight lbs/mft	kg/m	Approx. Weight lbs/mft	kg/m
<b>16 AWG (30/30) 1.50 mm<sup>2</sup></b>								<b>10 AWG (84/28) 6 mm<sup>2</sup></b>							
0043006	3	.480	12.2	30	128	190		00430213	4	.740	18.8	162	356	530	
00430053	4	.516	13.1	39	148	220		00430343	5	.835	21.2	213	464	690	
00430073	5	.555	14.1	54	175	260		<b>8 AWG (80/26) 10 mm<sup>2</sup></b>							
0043008	7	.689	17.5	77	255	380		00430223	4	.902	22.9	271	558	830	
0043009	12	.929	23.6	132	484	720		00430003	5	.972	24.7	343	672	1000	
0043010	18	.933	23.7	182	517	770		<b>6 AWG (128/26) 16 mm<sup>2</sup></b>							
0043011	24	1.094	27.8	263	672	1000		00430233	4	1.035	26.3	431	786	1170	
0043012	30	1.228	31.2	290	887	1320		00430323	5	1.122	28.5	516	941	1400	
<b>14 AWG (50/30) 2.50 mm<sup>2</sup></b>								<b>4 AWG (200/26) 25 mm<sup>2</sup></b>							
0043013	3	.531	13.5	50	168	250		00430243	4	1.307	33.2	675	1230	1830	
00430303	4	.622	15.8	67	222	330		<b>2 AWG (280/26) 35 mm<sup>2</sup></b>							
00430143	5	.661	16.8	83	262	390		00430253	4	1.406	35.7	947	1532	2280	
0043015	7	.764	19.4	121	343	510		<b>1 AWG (400/26) 50 mm<sup>2</sup></b>							
0043016	12	1.047	26.6	207	652	970		00430263	4	1.661	42.2	1351	2164	3220	
0043017	18	1.087	27.6	303	739	1100		<b>2/0 AWG (560/26) 70 mm<sup>2</sup></b>							
0043018	24	1.283	32.6	414	974	1450		00430283	4	1.835	46.6	1806	2822	4200	
0043019	30	1.445	36.7	518	1331	1980		<b>3/0 AWG (485/24) 95 mm<sup>2</sup></b>							
0043031	50	1.791	45.5	806	1982	2950		00430293	4	2.094	53.2	2451	3716	5530	
<b>12 AWG (56/28) 4 mm<sup>2</sup></b>															
00430203	4	.685	17.4	106	296	440									
00430333	5	.736	18.7	148	349	520									

# OLFLEX® CRANE VS (N)SHTÖU



(Formerly KRANFLEX® VS NSHTÖU)

Neoprene Pendant & Reel Cable for Applications Exposed to High Mechanical Stress

OLFLEX® CRANE VS (N)SHTÖU is specially designed with a reinforced abrasion resistant jacket, which enables this cable to be used in high stress applications that require frequent reeling and unreeling. Suitable for use indoors or outdoors and wet or dry conditions.

**Recommended Applications:**

For use in Hoists, Transport, Conveyor and Material handling equipment

**Application Advantage:**

- The reinforced abrasion resistant jacket absorbs mechanical stresses thus reducing jacket flexing fatigue and damage to the cores
- An additional supporting central core of aramide-meshwork absorbs applied tensile forces allowing for reeling and unreeling vertically over long distances

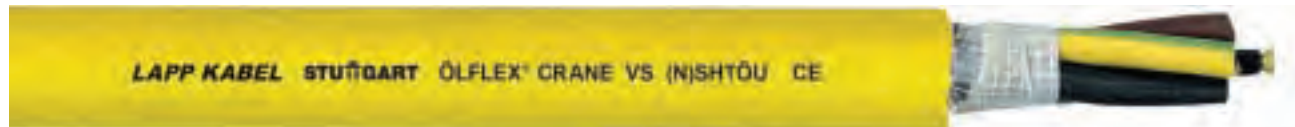

**Cable Attributes, See Page 653**

	Oil Resistance: OR-01		Flame Resistance: FR-01
	Motion Type: FL-01		Mechanical Properties: MP-01

**Availability:**

Standard put-ups are 164ft, 328ft, 1640ft, and 3280ft. Bulk reels can be cut to length.

**Complete the installation with:**



	SKINTOP® Strain Relief: Page 486		EPIC® Connectors: Page 251
	OLFLEX® Tubing: Page 546		SKINTOP® MS-M Page 502

**Technical Data:**

- |                         |   |                      |  |
|-------------------------|---|----------------------|--|
| Minimum Bending Radius: | 7.5 x outer diameter  | Conductor Stranding: | Fine wire per VDE 0295, Class 5 IEC 60228 Cl.5   |
| Temperature Range:      | -25°C to +80°C<br>- for flexing:<br>-45°C to +80°C<br>- for static: | Color Code:          | VDE 0293-308, Chart 6, Page 673<br>Black with white numbers plus a green/yellow ground |
| Nominal Voltage:        | 600/1000V   | Approvals:           | VDE 298 Part 4   |
| Test Voltage:           | 3000V   |                      |  |

Part Number	Number of Conductors includes ground	Nominal Outer Diameter inches	mm	Tension in lbs	Copper Weight lbs/mft	Approx. Weight lbs/mft	kg/km
<b>16 AWG (1.50 mm²)</b>							
0044008	7	.732	18.6	450	77	289	430
0044009	12	1.008	25.6	450	132	551	820
0044010	18	1.055	26.8	450	182	625	930
0044011	24	1.256	31.9	450	263	847	1260
0044036	36	1.409	35.8	450	395	1109	1650
<b>14 AWG (2.50 mm²)</b>							
0044015	7	.874	22.2	450	121	423	630
0044016	12	1.169	29.7	450	207	773	1150
<b>12 AWG (4 mm²)</b>							
00440333	5	.736	18.7	450	148	343	510
<b>8 AWG (10 mm²)</b>							
00440223	4	.902	22.9	450	271	558	830
<b>6 AWG (16 mm²)</b>							
00440233	4	1.035	26.3	450	431	786	1170
00440323	5	1.122	28.5	450	516	941	1400
<b>4 AWG (25 mm²)</b>							
00440243	4	1.307	33.2	450	675	1243	1850
<b>2 AWG (35 mm²)</b>							
00440253	4	1.406	35.7	630	947	1512	2250
<b>1 AWG (50 mm²)</b>							
00440263	4	1.661	42.2	900	1351	2184	3250
<b>2/0 AWG (70 mm²)</b>							
00440283	4	1.835	46.6	1260	1806	2822	4200
<b>3/0 AWG (95 mm²)</b>							
00440293	4	2.094	53.2	1710	2451	3729	5550

# Pendant and Reel Cable Installation Instructions

Applications	Motor reel without guidance 	Motor reel guidance with rollers 	Cable Carriage 
Guide Systems	Main applications	Main application	Suitable

## Installation Instructions and Recommendations

- Whenever possible, the delivery reel should be transported to the installation site. Avoid rolling the reel. If the reel cannot be mounted directly on the equipment, the cable should be unreeled with the aid of idle pulleys and a drag rope.
- During unreeeling, the cable must be taken only from revolving reels and only from the top while ensuring that tension is maintained and the cable is neither deflected nor dragged over sharp edges.
- Before installation, the cable must be laid out and stretched. If this is not possible, it is essential to keep the distance between the delivery reel and the equipment reels as long as possible. Avoid S-bends or other deflections when the cable is laid in position.

### Correct



Incorrect

Incorrect

- The cable must be spooled onto the equipment reel without twisting. It is equally important to avoid twisting when making connections.
- It is essential to use properly sized clamps (length 4x cable diameter) for fastening the cable ends in order to prevent crushing. The length of cable left unreeled before the fastening point must be at least 40x diameter, but it is advisable to use a compensating pulley here also.
- At least two coils must remain on the equipment reel when the cable has run out.

- For cables with an outer diameter of up to 21.5 mm the inner bending diameter should not be less than 10x and above that figure, 12.5 x the cable diameter.
- S-bends in the cable must be avoided. However, if this is not possible, the center spacing must be as shown below:

### Correct



### Incorrect

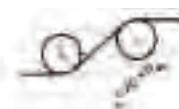

- The maximum permissible reeling speed is 2m/sec with and a maximum acceleration of 0.4m/sec<sup>2</sup>.
- The static continuous tensile stress should not exceed 15 N/mm<sup>2</sup> of the total copper cross section and the dynamic peak tensile stress may not exceed 25 N/mm<sup>2</sup>.
- The actual current rating in continuous operation is limited by:
  - The conductor cross section (see table 1)
  - The ambient temperature (see table 2)
  - The number of layers spooled on the reel (see table 3)
 The maximum permissible current on the installed cable is obtained from the following formula:  $I = I_{max} \times f_1 \times f_2$

Table 1		Table 2		Table 3	
Conductor cross section in mm <sup>2</sup>	I <sub>max</sub> in A	Ambient temp. in °C	f <sub>1</sub>	Number of layers	f <sub>2</sub>
1.5	18	≤30	1	1	.80
2.5	26	31 – 35	0.91	2	.68
4	34	36 – 40	0.82	3	.58
6	44	41 – 45	0.71	4	.60
10	61	46 – 50	0.58	5	.48
16	82	51 – 55	0.41	6	.46
25	108				
35	135				

# OLFLEX® CRANE PUR

## Reduced Diameter Pendant and Reel Cable



OLFLEX® CRANE PUR is a halogen-free, small diameter pendant cable with a yellow PUR jacket. This cable may be used in dry, damp and wet interiors as well as outdoors over a wide temperature range.

### Recommended Applications:

For use in Hoists, Transport and Conveying systems

### Application Advantage:

- Smaller diameter and bend radius may allow for smaller reels and drive engines resulting in cost savings
- Halogen-free material reduces toxins in case of fire
- The cable contains a supporting core that absorbs applied tensile forces making it possible to reel/unreel and guide vertically over long distances

### OLFLEX® CRANE PUR Construction:

Extra fine stranded copper conductors, TPE-E insulation, halogen-free PUR flame retardant yellow jacket with integrated supporting braid.



**Cable Attributes, See Page 653**

	Oil Resistance: OR-02		Flame Resistance: FR-02
	Motion Type: FL-02		Mechanical Properties: MP-04

**Availability:**

Standard put-ups are 164ft, 328ft, 1640ft, and 3280ft. Bulk reels can be cut to length.

**Complete the installation with:**

	SKINTOP® Strain Relief: Page 486		EPIC® Connectors: Page 251
	OLFLEX® Tubing: Page 546		SKINTOP® Strain Relief: Page 486

### Technical Data:

Minimum Bending Radius:	7.5 x outer diameter	Conductor Stranding:	Extra fine wire per VDE 0295, Class 5, IEC 228 Cl.6
Temperature Range:	-40°C to +80°C	Color Code:	Black with white numbers plus a green/yellow ground
Nominal Voltage:	600/ 1000V		
Test Voltage:	3500V		

Part Number	Number of Conductors includes ground	Nominal Outer Diameter		Tension in lbs	Copper Weight lbs/mft	Approx. Weight	
		inches	mm			lbs/mft	kg/km
16 AWG (1.50 mm <sup>2</sup> )							
0045210	7	.508	12.9	2500	68	161	239
0045211	12	.693	17.6	2500	116	269	401
0045212	18	.689	17.5	2500	174	341	507
0045213	24	.811	20.6	2500	232	452	673
0045214	36	1.035	26.3	2500	348	679	1011
14 AWG (2.50 mm <sup>2</sup> )							
0045220	7	.606	15.4	3000	113	241	358
0045221	12	.850	21.6	3000	194	416	619
0045222	18	.846	21.5	3000	290	533	793

# OLFLEX® CRANE



(Formerly NEOFLEX® Round)

All Weather Neoprene Pendant Control Cable

OLFLEX® CRANE is a small diameter, neoprene jacketed, pendant control cable. The cable is constructed with internal supporting elements and designed for use where long lengths are installed without the use of messenger supports.

**Recommended Applications:**

Suitable for use in machinery and applications that are continuously exposed to adverse weather conditions including Handling and hoisting gear, Construction machinery and Dockyard installations.

**Application Advantage:**





- Jacket is resistant to mild acids, oils, salt water and most chemicals and solvents
- UV resistant cable
- The firm but elastic insulation absorbs impact and pressure
- Extremely durable and flexible jacket provides protection to inner conductors

**OLFLEX® CRANE Construction:**

Stranded bare copper conductors; rubber insulation; special supporting elements; dry lubricant; black neoprene jacket



**Cable Attributes, See Page 653**





	Oil Resistance: OR-01		Flame Resistance: FR-02
	Motion Type: FL-02		Mechanical Properties: MP-01

**Availability:**









Standard put-ups are 328ft, 1640ft, and 3280ft. Bulk reels can be cut to length.

**Complete the installation with:**

	SKINTOP® Strain Relief: Page 486		EPIC® Connectors: Page 251
	OLFLEX® Tubing: Page 546		SKINTOP® Strain Relief: Page 486

**Technical Data:**

	Minimum Bending Radius: for flexible use:	12.5 x outer diameter		Conductor Stranding:	Fine wire per VDE 0295
	Temperature Range: - for flexing: - for static:	-25°C to + 80°C -40°C to + 80°C		Color Code: - up to 5 conductors- - 6 or more conductors-	VDE 0293-308, Chart 6, Page 673 Black with white numbers plus a green/yellow ground
	Rated Voltage:	300/ 500V		Approvals:	Based on VDE Specifications
	Test Voltage:	3000V			

# OLFLEX® CRANE

(Formerly NEOFLEX® Round)

All Weather Neoprene Pendant Control Cable



Part Number	Number of Conductors includes ground	Nominal Outer Diameter		Tension in lbs	Copper Weight lbs/mft	Approx. Weight	
		inches	mm			lbs/mft	kg/km
<b>18 AWG (56/34) 1.00 mm<sup>2</sup></b>							
0039001	2	.291	7.4	68	13	61	91
0039002	3	.327	8.3	68	20	74	110
00390033	4	.350	8.9	68	27	96	142
00390043	5	.409	10.4	68	32	115	171
0039107	7	.508	12.9	68	46	138	205
0039109	9	.567	14.4	68	61	185	275
0039054	12	.728	18.5	81	83	262	390
0039116	16	.705	17.9	108	111	291	433
0039055	18	.756	19.2	121	124	317	472
0039120	20	.807	20.5	135	138	343	510
0039056	24	.870	22.1	162	166	438	651
0039057	36	1.028	26.1	243	249	612	910
0039148	48	1.165	29.6	324	310	837	1245
0039154	54	1.244	31.6	364	348	941	1400
<b>16 AWG (48/32) 1.50 mm<sup>2</sup></b>							
0039017	2	.315	8.0	68	20	65	96
0039018	3	.343	8.7	68	30	77	114
00390193	4	.390	9.9	68	40	101	150
00390203	5	.429	10.9	68	50	122	181
0039061	7	.551	14.0	71	69	208	310
0039208	8	.598	15.2	81	82	225	334
0039209	9	.626	15.9	91	93	241	359
0039210	10	.669	17.0	101	103	273	406
0039211	11	.720	18.3	111	113	309	459
0039058	12	.783	19.9	121	124	348	517
0039213	13	.803	20.4	131	133	385	572
0039215	15	.929	23.6	152	154	397	590
0039059	18	.823	20.9	182	186	416	619
0039219	19	.854	21.7	192	196	450	670
0039060	24	.921	23.4	243	249	550	818
0039242	42	1.181	30.0	425	431	928	1380
<b>14 AWG (80/32) 2.50 mm<sup>2</sup></b>							
0039034	2	.382	9.7	68	33	96	143
0039035	3	.402	10.2	68	50	116	173
00390363	4	.457	11.6	68	66	141	210
00390373	5	.488	12.4	84	81	172	256
0039307	7	.654	16.6	118	115	258	384
0039309	9	.744	18.9	152	154	364	542
0039312	12	.917	23.3	202	207	465	691
0039316	16	.897	22.8	270	276	547	814
0039318	18	.961	24.4	303	290	600	892
0039324	24	1.122	28.5	405	387	822	1222
0039336	36	1.307	33.2	607	581	1168	1738
<b>12 AWG (128/32) 4 mm<sup>2</sup></b>							
00390463	4	.598	15.2	108	106	275	408
00390473	5	.661	16.8	135	132	291	433
<b>10 AWG (194/32) 6 mm<sup>2</sup></b>							
00390483	4	.661	16.8	162	159	299	445
00390493	5	.756	19.2	202	198	383	569
<b>8 AWG (322/32) 10 mm<sup>2</sup></b>							
00390503	4	.858	21.8	270	264	487	725
00390513	5	.969	24.6	337	330	621	923
<b>6 AWG (516/32) 16 mm<sup>2</sup></b>							
00390523	4	1.000	25.4	432	423	691	1028
00390533	5	1.102	28.0	540	529	847	1260

# OLFLEX® FLAT

UL/CSA Approved Flat Festoon Cable (PVC)



OLFLEX® FLAT is a UL/CSA approved PVC festoon power and control cable. The specially formulated PVC compound is UV resistant and allows continuous festooning over a wide temperature range for both indoor and outdoor applications.

**Recommended Applications:**

For use on Overhead crane, Material handling systems and as Supply line for moving machine parts.

**Application Advantage:**

- Flat construction allows cables to be stacked for applications where space is at a premium
- Meets North American approvals

**OLFLEX® Flat Construction:**

Stranded bare copper conductors; PVC insulation; black or yellow PVC jacket.



**Cable Attributes, See Page 653**

	Oil Resistance: OR-01		Flame Resistance: FR-02
	Motion Type: FL-02		Mechanical Properties: MP-01

Minimums may apply.

**Complete the installation with:**

	SKINTOP® Strain Relief: Page 486		EPIC® Connectors: Page 251
	SVF-K Flat Gland Page 237		FLEXIMARK® Marking: Page 596

**Technical Data:**

- |  |                    |                  |  |             |   |
|--|--------------------|------------------|--|-------------|---|
|  | Temperature Range: | -55°C to + 105°C |  | Color Code: | Chart 12, Page 676<br>Colors plus numbers |
|  | Rated Voltage:     | 600V             |  | Approvals:  | UL: Listed<br>CSA: Certified              |

Part Number	Color		Number of Conductors	Nominal Outer Diameter		Copper Weight lbs/mft	Approx. Weight	
	Black	Yellow		inches	mm		lbs/mft	kg/km
<b>16 AWG (65/34) 1.50 mm<sup>2</sup></b>								
811261	811234		8	.200 x 1.110	5.1 x 28.2	64	180	268
811262	811232		12	.200 x 1.605	5.1 x 40.8	96	270	402
<b>14 AWG (41/30) 2.50 mm<sup>2</sup></b>								
811259	811269		4	.210 x .625	5.3 x 15.9	51	120	179
811263	811233		8	.210 x 1.175	5.3 x 29.9	103	220	328
811267	811272		12	.210 x 1.700	5.3 x 43.2	155	340	507
<b>12 AWG (65/30) 4 mm<sup>2</sup></b>								
811264	811235		4	.230 x .711	5.8 x 18.0	83	160	238
811273	811236		8	.230 x 1.340	5.8 x 34.0	166	320	477
<b>10 AWG (105/30) 6 mm<sup>2</sup></b>								
811266	811237		4	.270 x .880	6.9 x 22.4	132	240	358
<b>8 AWG (168/30) 10 mm<sup>2</sup></b>								
811270	811238		4	.365 x 1.190	9.3 x 30.2	212	420	626
<b>6 AWG (266/30) 16 mm<sup>2</sup></b>								
811271	811239		4	.430 x 1.450	10.9 x 36.8	333	600	894
<b>4 AWG (420/30) 25 mm<sup>2</sup></b>								
811279	811280		4	.490 x 1.690	12.5 x 42.9	560	750	1118
<b>2 AWG (665/30) 35 mm<sup>2</sup></b>								
811274	811240		4	.590 x 1.955	15.0 x 49.7	852	1270	1892
<b>Shielded Black Jacket</b>								
<b>16 AWG (65/34) 1.50 mm<sup>2</sup></b>								
811358			4	.240 x .760	6.1 x 19.3	69	160	239
811357			8	.240 x 1.445	6.1 x 36.7	138	220	328
811356			12	.240 x 2.110	6.1 x 53.6	207	460	685

# OLFLEX® LIFT F

## Flat Festoon Cable



OLFLEX® LIFT F is a flat control cable with a special cold resistant PVC insulation and black PVC jacket. According to VDE definition, this cable can also be used as an elevator control cable up to 35 meters (115 feet) suspension length with a maximum travel speed of 1.6m/sec. Mainly suited for indoor use.

### Recommended Applications:

For use on Conveying systems, Hoists, Cable trolleys and as supply line for moving machine parts.

### Application Advantage:

- Flame retardant jacket
- Improved flexibility due to finely stranded conductors
- Meets the requirements of the harmonized PVC flat cable H07VVH6-F

### OLFLEX® LIFT F Construction:

Finely stranded bare copper conductors; PVC insulation; dry lubricant; black PVC jacket.



Cable Attributes, See Page 653			
	Oil Resistance: OR-02		Flame Resistance: FR-02
	Motion Type: FL-02		Mechanical Properties: MP-02

### Technical Data:

	Minimum Bending Radius:	10 x cable thickness		Conductor Stranding:	Fine wire per VDE 0295, Class 5, IEC 90228 Cl. 5 or 6
	Temperature Range:	≤ 1.0                      0°C to +70°C ≥ 1.5                      -15°C to +70°C		Color Code:	- up to 5 conductors- - 7 or more conductors-  VDE 0293-308, Chart 6, Page 673 Black with white numbers plus a green/yellow ground
	Rated Voltage:	≤ 1.0                      300/500V ≥ 1.5                      450/750V		Approvals:	Based on VDE 0281 (H06VVH-6 or H07VVH6-F)

Part Number	Number of Conductors includes ground	Single Wire Diameter mm	Nominal Outer Diameter		Copper Weight lbs/mft	Approx. Weight	
			inches	mm		lbs/mft	kg/km
<b>18 AWG (1.00 mm<sup>2</sup>)</b>							
0042020	12	0.21	.169 x 1.378	4.3 x 35	77	263	392
0042021	16	0.21	.169 x 1.810	4.3 x 46	103	350	521
0042022	20	0.21	.169 x 2.244	4.3 x 57	129	433	645
0042023	24	0.21	.169 x 2.677	4.3 x 68	155	519	772
<b>16 AWG (1.50 mm<sup>2</sup>)</b>							
00420013	4	0.15	.197 x .591	5 x 15	39	89	132
00420023	5	0.15	.197 x .748	5 x 19	48	114	170
0042003	7	0.15	.197 x 1.023	5 x 26	68	159	236
0042004	8	0.15	.197 x 1.102	5 x 28	77	179	266
0042005	10	0.15	.197 x 1.377	5 x 35	97	224	333
0042006	12	0.15	.197 x 1.614	5 x 41	116	284	422
<b>14 AWG (2.50 mm<sup>2</sup>)</b>							
00420073	4	0.15	.224 x .724	5.7 x 18.4	65	138	206
00420083	5	0.15	.224 x .909	5.7 x 23.1	81	173	257
0042009	7	0.15	.224 x 1.240	5.7 x 31.5	113	232	345
0042010	8	0.15	.224 x 1.346	5.7 x 34.2	129	262	390
0042050	12	0.15	.224 x 2.008	5.7 x 51.0	194	390	580
<b>12 AWG (4 mm<sup>2</sup>)</b>							
00420113	4	0.15	.260 x .803	6.6 x 20.4	103	230	343
0042012	7	0.15	.260 x 1.394	6.6 x 35.4	181	396	589
<b>10 AWG (6 mm<sup>2</sup>)</b>							
00420133	4	0.2	.287 x .913	7.3 x 23.2	155	286	425
<b>8 AWG (10 mm<sup>2</sup>)</b>							
00420143	4	0.3	.354 x 1.118	9 x 28.4	258	476	709
<b>6 AWG (16 mm<sup>2</sup>)</b>							
00420153	4	0.3	.413 x 1.339	10.5 x 34	413	682	1015
<b>4 AWG (25 mm<sup>2</sup>)</b>							
00420163	4	0.3	.500 x 1.654	12.7 x 42	645	918	1366

# OLFLEX® CRANE 2S



(Formerly OLFLEX® TRAGO 2S)

Pendant Cable with Two Steel Supporting Elements

OLFLEX® CRANE 2S is a PVC insulated and jacketed cable for connecting control panels. This cable contains two special torsion-free steel supporting elements integrated in parallel on both sides of the outer jacket, which absorbs the resulting tensile load during operation. The tensile strength is 2100 N and allows free carrying installation up to 150 meters (492 feet) in length.

**Recommended Applications:**

Suitable for outdoor use and as self-supporting shaft cable. This is not an elevator cable.

**Application Advantage:**

- Jacket is weather resistant and flame retardant
- Cable is flexible even at colder temperatures with slide wrap between cores and outer jacket
- Contains double carrying security members for connecting control panels

**OLFLEX® CRANE 2S Construction:**

Finely stranded bare copper conductors; PVC insulation; textile wrap; black PVC jacket. Two steel supporting members parallel on opposite sides of the jacket.



**Cable Attributes, See Page 653**

	Oil Resistance: OR-02		Flame Resistance: FR-01
	Motion Type: FL-01		Mechanical Properties: MP-02

**Availability:**

Standard Put-ups are 164ft, 328ft, 820ft, 1640ft, 3280ft and bulk reels cut to length.

**Technical Data:**

- |                         |                     |                      |   |
|-------------------------|---------------------|----------------------|---|
| Minimum Bending Radius: | 20 x outer diameter | Conductor Stranding: | Superfine wire per VDE 0295, Class 6/IEC 60228 Cl.6 |
| Temperature Range:      | -15°C to +70°C      | Color Code:          | Black with white numbers plus green/yellow ground   |
| Rated Voltage:          | 300/500V            | Approvals:           | Based on VDE 0250                                   |
| Test Voltage:           | 3000V               |                      |   |

Part Number	Number of Conductors includes ground	Nominal Outer Diameter		Copper Weight lbs/mft	Approx. Weight	
		inches	mm		lbs/mft	kg/km
16 AWG (1.50 mm <sup>2</sup> )						
0027503	8	.587	14.9	77	232	345
0027504	12	.638	16.2	116	295	439
0027505	20	.791	20.1	194	453	674

# OLFLEX® CRANE F

(Formerly NEOFLEX® FLAT CABLE)

Flat Festoon Cable (Neoprene)



OLFLEX® CRANE F is a flexible, oil resistant, neoprene jacketed festoon, power and control cable.

### Recommended Applications:

For indoor and outdoor use on overhead crane and material handling systems.

### Application Advantage:





- Weather and UV resistant jacket for extreme environmental conditions
- Flame retardant jacket
- May be used in continuous flex applications over a wide temperature range
- The flat construction allows cables to be stacked for applications where space is at a premium

### OLFLEX® CRANE F Construction:







Stranded bare copper conductors; rubber insulation; dry lubricant; black neoprene jacket.



### Cable Attributes, See Page 653

	Oil Resistance: OR-01		Flame Resistance: FR-02
	Motion Type: FL-02		Mechanical Properties: MP-01

### Technical Data:

	Minimum Bending Radius:	10 x cable thickness		Color Code:	- up to 5 conductors- - 7 or more conductors-	VDE 0293-308 Chart 6, Page 673 Black with white numbers plus a green/yellow ground
	Temperature Range:	-25°C to +90°C		Approvals:	Based on VDE 0250 (NGFLGOU)	
	Rated Voltage:	300/500V				
	Conductor Stranding:	Fine wire per VDE 0295, Class 5, IEC 90228 Cl. 5 or 6				

Part Number	Old Part Number	Number of Conductors includes ground	Nominal Thickness x Width inches	mm	Copper Weight lbs/mft	Approx. Weight lbs/mft	kg/km
<b>16 AWG (85/34) 1.50 mm<sup>2</sup></b>							
0041041	00410013	4	0.2 x 0.689	6.2 x 17.5	39	134	200
0041042	00410023	5	0.2 x 0.846	6.2 x 21.5	48	161	240
0041043	0041003	7	0.2 x 1.142	6.2 x 29.0	68	242	360
0041044	0041004	8	0.2 x 1.240	6.2 x 31.5	77	249	370
0041045	0041005	10	0.3 x 1.575	6.5 x 40.0	97	349	520
0041046	0041006	12	0.3 x 1.850	6.5 x 47.0	116	417	620
<b>14 AWG (140/34) 2.50 mm<sup>2</sup></b>							
0041047	00410073	4	0.3 x 0.827	7.5 x 21	65	188	280
0041048	00410153	5	0.3 x 1.063	7.5 x 27	81	269	400
0041049	0041008	7	0.3 x 1.380	7.5 x 35	113	349	520
0041050	0041009	8	0.3 x 1.535	7.5 x 39	129	370	550
0041051	0041020	12	0.3 x 2.205	8.0 x 56	194	538	800
<b>12 AWG (228/34) 4 mm<sup>2</sup></b>							
0041052	00410103	4	0.4 x 1.024	9.0 x 26	103	276	410
0041053	0041011	7	0.4 x 1.654	9.0 x 42	181	470	700
<b>10 AWG (190/34) 6 mm<sup>2</sup></b>							
0041054	00410123	4	0.4 x 1.142	9.5 x 29	155	403	600
0041055	00410233	5	0.4 x 1.378	9.5 x 35	194	437	650
0041056	0041024	7	0.4 x 1.654	9.5 x 42	271	571	850
<b>8 AWG (143/28) 10 mm<sup>2</sup></b>							
0041057	00410133	4	0.4 x 1.299	11 x 33	258	538	800
0041058	00410213	5	0.4 x 1.732	11 x 44	323	672	1000
<b>6 AWG (228/28) 16 mm<sup>2</sup></b>							
0041059	00410143	4	0.5 x 1.496	13 x 38	413	773	1150
<b>4 AWG (350/28) 25 mm<sup>2</sup></b>							
0041060	00410253	4	0.6 x 1.949	15 x 49.5	645	1142	1700
<b>2 AWG (495/28) 35 mm<sup>2</sup></b>							
0041061	00410273	4	0.7 x 2.165	17 x 55	903	1478	2200
<b>1 AWG (708/28) 50 mm<sup>2</sup></b>							
0041062	00410293	4	0.7 x 2.480	19 x 63	1290	2016	3000
<b>2/0 AWG (560/26) 70 mm<sup>2</sup></b>							
0041063	00410303	4	0.9 x 2.795	22 x 71	1806	2688	4000

# SVF & SVF-K Series Cable Connectors



Compact Strain Relief Connectors for Flat and Festoon Cable  
Plastic and Brass

## SVF Brass Connector

The SVF is a compact strain relief connector for flat cable made of nickel-plated brass. The special neoprene bushing provides a flexible seal over a wide range of cable widths.

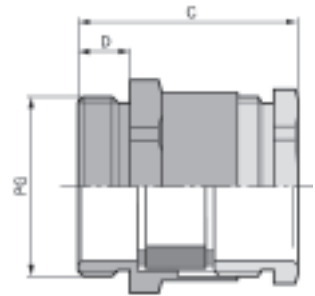

### Technical Data:

- Material: Body of nickel-plated brass with neoprene bushing
- Seal: IP 54
- Temperature Range: -20°C to +100°C

Part Number	Thread Type & Size	Flat Cable Width		Cable Thickness		C Overall Length inches	D Thread Length inches	Wrenching Top inches	Flats inches Mounting	Standard Pack Size	
		min. inches	max. mm <sup>2</sup>	min. inches	max. mm <sup>2</sup>						
52005480	PG-16	--	--	.591	15	--	.197	1.08	.866	.945	25
52005490	PG-21	.354	9	.827	21	.118	.315	1.18	1.102	1.181	25
52005500	PG-29	.551	14	1.181	30	.157	.453	1.24	1.457	1.575	10
52005510	PG-36	.945	24	1.575	40	.157	.453	1.42	1.850	1.969	10
52005520	PG-42	1.142	29	1.772	45	.197	.472	1.57	2.126	2.244	5
52005530	PG-48	1.139	34	1.969	50	.197	.472	1.63	2.362	2.598	5

## SVF-K Plastic Connector

The SVF-K is a compact strain relief connector for flat cable made of polystyrene. The special neoprene bushing provides a flexible seal over a wide range of cable widths.

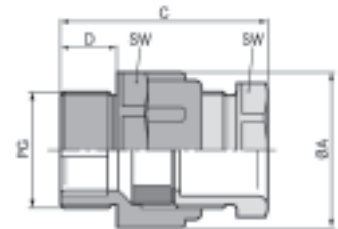

### Technical Data:

- Material: Body of polystyrene with neoprene bushing
- Seal: IP 54
- Temperature Range: -20°C to +60°C

Part Number	Thread Type & Size	Flat Cable Width		Cable Thickness		C Overall Length inches	D Thread Length inches	Wrenching Top inches	Flats inches Mounting	Standard Pack Size	
		min. inches	max. mm <sup>2</sup>	min. inches	max. mm <sup>2</sup>						
52005470	PG-16	--	--	.591	15	--	.197	1.56	.906	1.063	25
52005680	PG-21	.354	9	.827	21	.118	.315	1.69	1.181	1.260	25
52005690	PG-29	.551	14	1.181	30	.157	.453	1.77	1.614	1.634	25
52005700	PG-36	.945	24	1.575	40	.157	.453	2.01	1.969	2.087	10
52005710	PG-42	1.142	29	1.772	45	.197	.472	2.13	2.165	2.362	5
52005720	PG-48	1.139	34	1.969	50	.197	.472	2.17	2.362	2.559	5

