

**CONSTRUCCIÓN / CONSTRUCTION / CONSTRUCTION /
BAUWESEN / COSTRUZIONI / CONSTRUCÇÃO / СТРОИТЕЛЬСТВО**

EGA Master ofrece una amplia gama de cortaaazulejos manuales diseñados para cortes rectos, angulares o circulares de cerámicas hasta 120cm de ancho.

EGA Master offers a wide range of tile cutters designed for straight, angular and circular ceramic cuts up to 120cm wide.

Ega Master offre une grande gamme de coupe carreaux manuels concus pour des coupes droites, angulaires ou circulaires pour des dimensions maximum de 120 cm

Todos ellos equipados con guías tubulares o macizas para lograr un corte más preciso y profesional, y provista de una bolsa de nylon para facilitar su transporte.

All of them equipped with tubular or solid guides for accurate and professional cuts, and provided with a nylon bag for their easy transport.

Tous sont équipés de guides tubulaires ou pleins pour obtenir une coupe plus précise et professionnelle, et présentés dans une poche en nylon pour faciliter le transport

0. Diseñado para realizar cortes rectos y angulares de cerámicas hasta 120cm.

Designed for straight and angular ceramic cutting up to 120cm.

Conçus pour réaliser des coupes droites ou angulaires de céramiques de 120 cm.

2. Rodamientos ajustables para un corte más preciso.

Adjustable bearings for accurate cutting.

Roulements ajustables pour une meilleure coupe.

4. Conjunto de escuadra giratoria con escala métrica y sistema de medición angular para cortes rectos de 0° a 45°.

Swivel square set with metric scale and angular measuring system for 0° to 45° straight cutting.

Système d'équerre rotative avec une graduation métrique pour des coupes de 0° à 45°.

1. Única guía maciza de acero para una mejor visión de rayado y corte.

One solid steel guide for better view of the scrapping and cutting process.

Un guide solide en acier pour une meilleure vue du marquage et une meilleure coupe.

3. Tope lateral para realizar cortes repetitivos rectos y a 45°.

Side stop for repetitive straight and 45° cutting.

Côte latérale pour faire des coupes droites et à 45° répétitives.

5. Base de aluminio con soportes laterales para un mejor apoyo de cerámicas de gran tamaño.

Aluminium base with movable large extension pads to stand larger ceramic sizes.

Base en aluminium avec des supports latéraux pour un meilleur appui de céramiques de grandes dimensions.

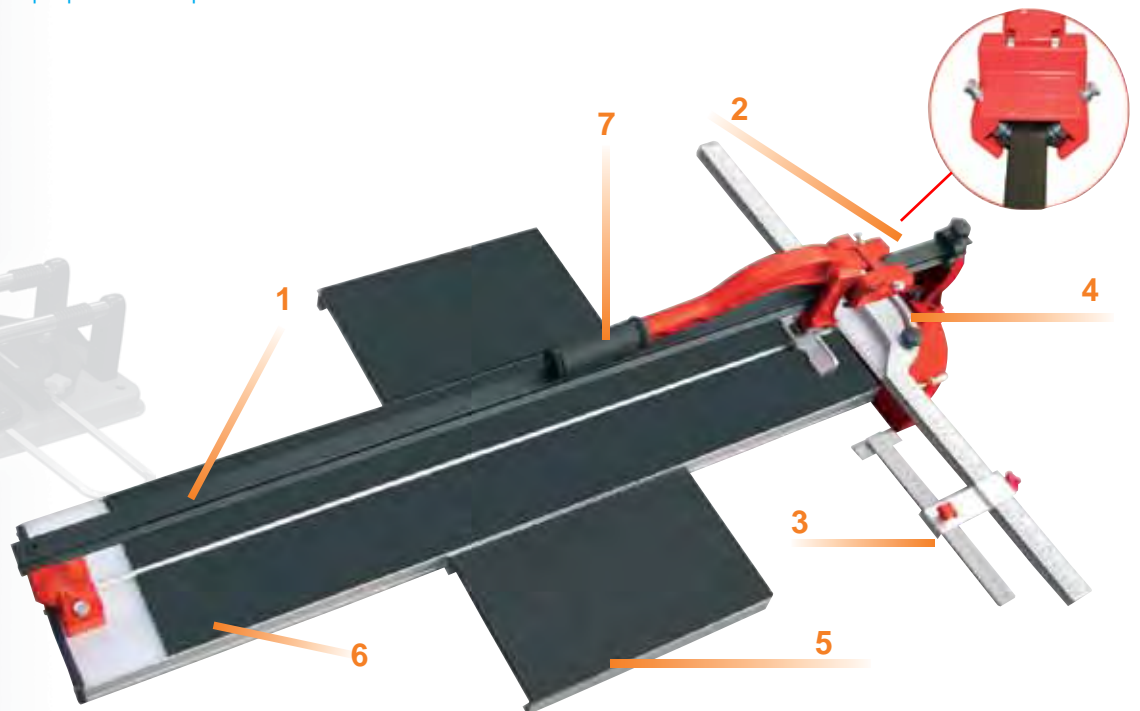

6. Base con efecto amortiguante para lograr cortes con máxima precisión.

Cushion effect base to get highest accuracy cuts.

Base avec effet amortisseur pour obtenir des coupes de grande précision.

7. Mango ergonómico para un fácil agarre y un uso confortable.

Ergonomic handle for easy gripping and comfortable use.

Manche ergonomique pour une meilleure prise et un usage facile.

22 CONSTRUCCIÓN / CONSTRUCTION / CONSTRUCTION / BAUWESEN / COSTRUZIONI / CONSTRUÇÃO / СТРОИТЕЛЬСТВО

CORTAAZULEJOS MANUALES / HAND TILE CUTTERS / COUPE CARREAUX MANUELS /
MANUELLER KACHELSCHNEIDER / TAGLIAPIASTRELLE / CORTA AZULEIJOS MANUAIS /
РУЧНОЙ ПЛИТКОРЕЗ

CLASSIC



COD					
63922	40cm	4-12mm	●	4,0	63943
63923	60cm			5,0	

Especificaciones técnicas / Technical specification / Détails techniques

Guías tubulares de acero cromadas y rectificadas / Rectified and chromed steel tubular guides / Guides rectifiés en acire chromé

Con separador móvil / Adjustable breaking system / Avec séparateur mobile

Base con efecto amortiguante / Base with cushion effect / Base avec effet amortisseur

Visión directa de rayado y corte / Direct view of scrapping and cutting process / Vue directe du marquage et du processus de coupe

Tope lateral para realizar cortes repetitivos rectos y a 45° / Side limit for repetitive straight and 45° cuts / Câle latérale pour des coupes droites répétitives et des coupes à 45°

Cuchilla de carburo de tungsteno (WIDIA) / Tungsten carbide cutting wheel (WIDIA) / Lame en carbure de tungstène (WIDIA)



COD					
63924	40cm	4-12mm	30-80mm	5,0	63943
					Ø22x6x2mm

Especificaciones técnicas / Technical specification / Détails techniques

Guías tubulares de acero cromadas y rectificadas / Rectified and chromed steel tubular guides / Guides rectifiés en acire chromé

Con separador móvil / Adjustable breaking system / Avec séparateur mobile

Base con efecto amortiguante / Base with cushion effect / Base avec effet amortisseur

Visión directa de rayado y corte / Direct view of scrapping and cutting process / Vue directe du marquage et du processus de coupe

Tope lateral para realizar cortes repetitivos rectos / Side limit for repetitive straight cuts / Câle latérale pour des coupes droites répétitives

Sistema de medición angular para cortes rectos de 0 a 45° / Angular measuring system for 0 to 45° straight cutting / Système de mesure angulaire pour des coupes droites de 0° à 45°

Taladro para cortes circulares / Drill hole for circular cutting / Mèche pour des coupes circulaires

Cuchilla de carburo de tungsteno (WIDIA) / Tungsten carbide cutting wheel (WIDIA) / Lame en carbure de tungstène (WIDIA)

22 CONSTRUCCIÓN / CONSTRUCTION / CONSTRUCTION / BAUWESEN / COSTRUZIONI / CONSTRUÇÃO / СТРОИТЕЛЬСТВО

MASTER



COD					Kg.		
63934	60cm	≤ 16mm	●		14	63947	Ø20x14x6mm
63935	70cm				15		
63936	80cm				16		
63937	90cm				17		
63938	100cm				18		
63939	120cm				20		

Especificaciones técnicas / Technical specification / Détails techniques

Guí a maciza de acero cromada y rectificada / Rectified and chromed steel solid guides / Guide robuste en acier chromé et rectifié

Con separador móvil / Adjustable breaking system / Avec séparateur mobile

Base con efecto amortiguante / Base with cushion effect / Base avec effet amortisseur

Visión directa de rayado y corte / Direct view of scrapping and cutting process / Vue directe du marquage et du processus de coupe

Tope lateral para realizar cortes repetitivos rectos y a 45° / Side limit for repetitive straight and 45° cuts / Câle latérale pour des coupes droites répétitives et des coupes à 45°

Conjunto de escuadra giratoria con escala métrica y sistema de medición angular para cortes rectos de 0 a 45° / Swivel square set with metric scale and angular measuring system for 0 to 45° straight cutting / Système d'équerre giratoire avec graduation métrique et système de mesure d'angle pour des coupes droites de 0° à 45°

Base de aluminio con soportes laterales móviles para un mejor apoyo de azulejos de gran tamaño / Aluminium base with movable large extension pads for support of the larger tile sizes / Base aluminium avec des support latéraux pour un meilleur appui des céramiques de grande dimension

Cuchilla de carburo de tungsteno (WIDIA) recubierta de nitruro de titanio (TiN) / Titanio (TiN) coated tungsten carbide (WIDIA) cutting wheel / Lame en carbure de tungstène (WIDIA) recouverte de nitrure de titane

EGGA Master S.A.

ART IN INNOVATION



22

CONSTRUCCIÓN / CONSTRUCTION / CONSTRUCTION / BAUWESEN / COSTRUZIONI / CONSTRUCCÃO / СТРОИТЕЛЬСТВО

PALAS / SHOVELS / PELLAS / SCHAUFELN / PALE / PAS / ЛОПАТКОУЛАВЛИВАТЕЛИ



COD	L	A	B	Kg.	
67185	1030	265	325	1,9	6
67186		285	335	1,9	



COD	L	A	B	Kg.	
67187	1020	265	325	1,9	6
67188		285	335	1,9	



COD	L	A	B	Kg.	
67189	1400	265	325	1,9	6

22 CONSTRUCCIÓN / CONSTRUCTION / CONSTRUCTION / BAUWESEN / COSTRUZIONI / CONSTRUÇÃO / СТРОИТЕЛЬСТВО

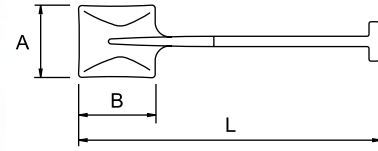

COD	L	A	B	Kg.	
67196	1020	245	335	1,8	6
67197		285	340	1,9	

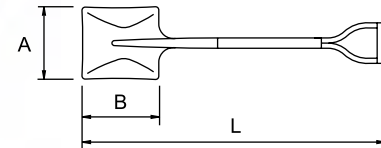

COD	L	A	B	Kg.	
67198	1020	245	335	2,1	6
67199		285	340	2,1	

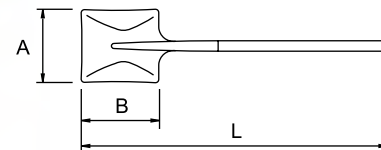

COD	L	A	B	Kg.	
67200	1400	245	335	2,0	6
67201		285	340	2,0	

22

CONSTRUCCIÓN / CONSTRUCTION / CONSTRUCTION / BAUWESEN / COSTRUZIONI / CONSTRUCCÃO / СТРОИТЕЛЬСТВО

ALUMINIUM

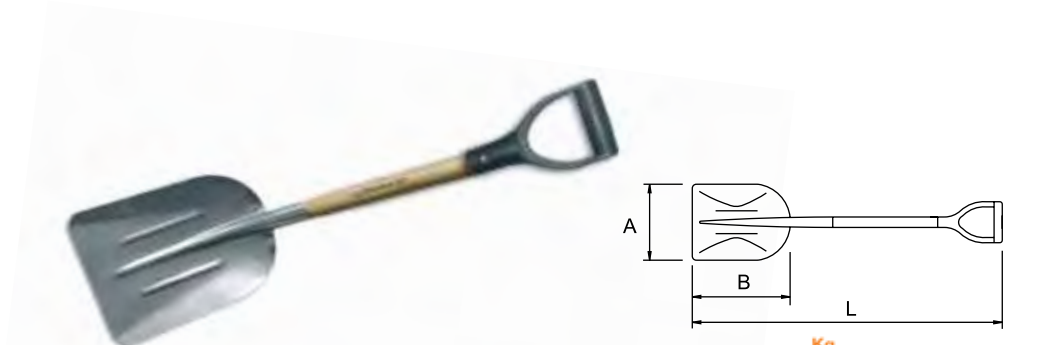

COD	L	A	B	Kg.	
67208	1300	345	390	1,6	6

ALUMINIUM

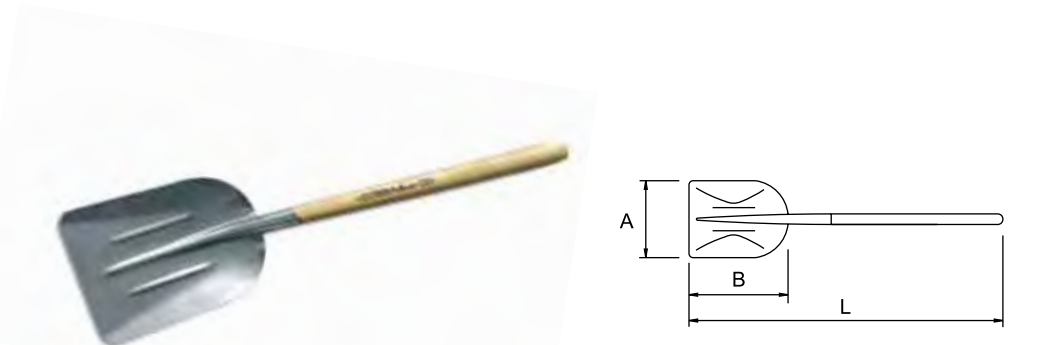

COD	L	A	B	Kg.	
67209	1620	345	390	1,6	6

ALUMINIUM

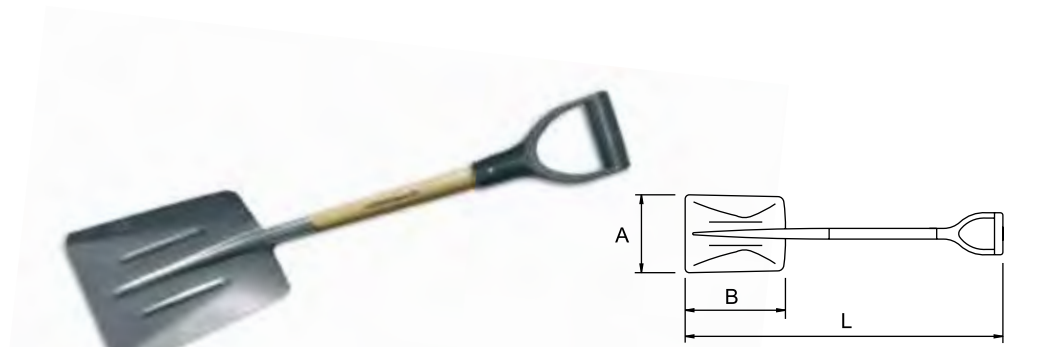

COD	L	A	B	Kg.	
67212	960	250	305	0,9	6

22 CONSTRUCCIÓN / CONSTRUCTION / CONSTRUCTION / BAUWESEN / COSTRUZIONI / CONSTRUÇÃO / СТРОИТЕЛЬСТВО

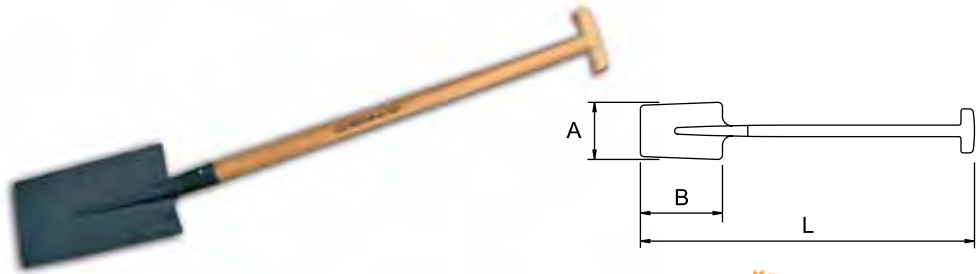

COD	L	A	B	Kg.	
67215	955	160	260	1,6	6

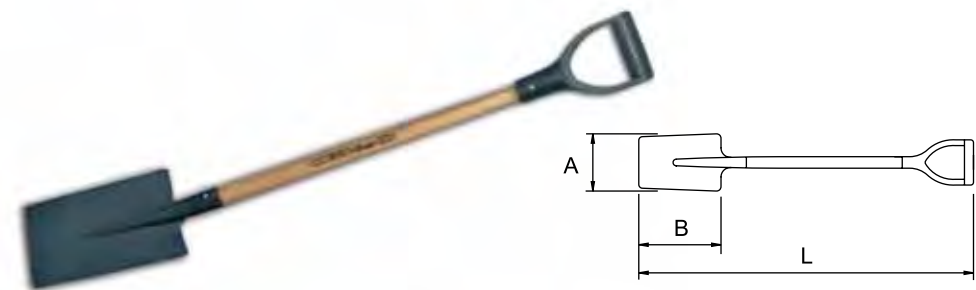

COD	L	A	B	Kg.	
67216	955	160	260	1,7	6

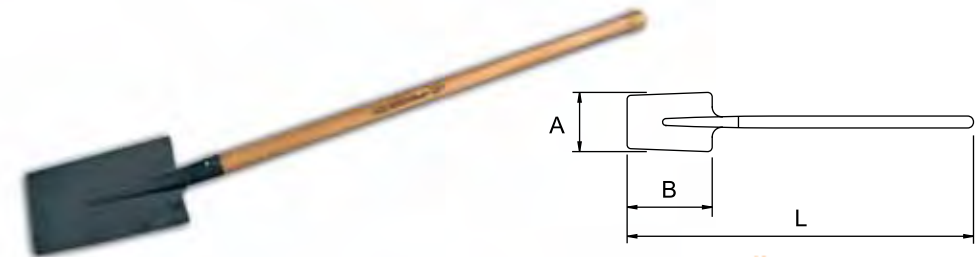

COD	L	A	B	Kg.	
67218	1280	150	240	1,6	6

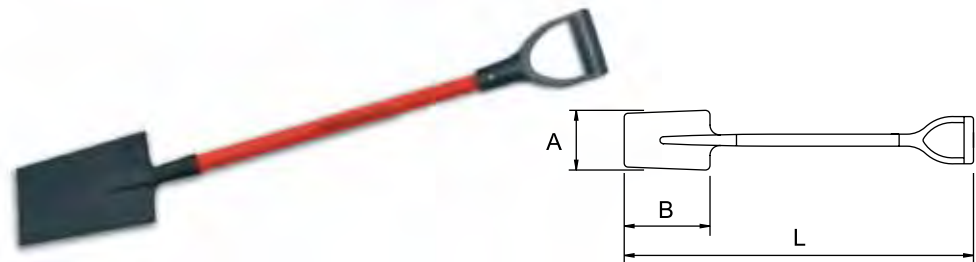

COD	L	A	B	Kg.	
67219	1010	150	240	1,7	6

22

CONSTRUCCIÓN / CONSTRUCTION / CONSTRUCTION / BAUWESEN / COSTRUZIONI / CONSTRUÇÃO / СТРОИТЕЛЬСТВО

PALETAS / BRICKLAYERS / TRUELLES ET COUTEAUX / MAURERKELLEN / CAZZUOLE /
COLHERES / МАСТЕРКИ

HOJA DE ACERO ESPECIAL, VAGIADA, PULIDA Y TEMPLADA. MANGO BARNIZADO.
ALLOY STEEL BLADE, DOUBLE POLISHED AND HARDENED. VARNISHED HANDLE.
ACIER SPECIAL DOUBLEMENT POLI ET TREMPE. MANCHE VERNIE.
KLINGE AUS SPEZIALSTAHL, PLANGESCHLIFFEN. POLIERT UND GEHÄRTET.
ACCIAO SPECIALE LAMA PULITA IMPUGNATURA VERNICIATA.
FOLHA DE AÇO ESPECIAL LAMA PULIDA E TEMPERADA CABO ENVERNIZADO.
ПЛАСТИНА ИЗ СТАЛЬНОГО СПЛАВА, ДВОЙНАЯ ПОЛИРОВКА И ЗАКАЛКА, ЛАКИРОВАННАЯ РУКОЯТКА

COD	A	B	gr.		
67000	50	105	120	6	1
67001	70	130	135		

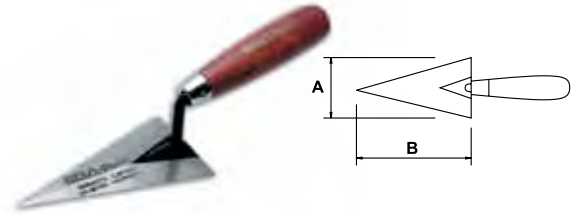

COD	A	B	gr.		
67017	50	105	120	6	1
67002	70	130	135		

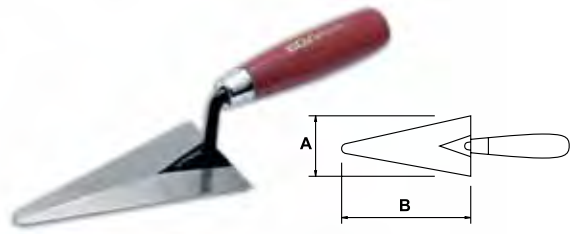

COD	A	B	C	gr.		
67004	87	180	115	340	6	1

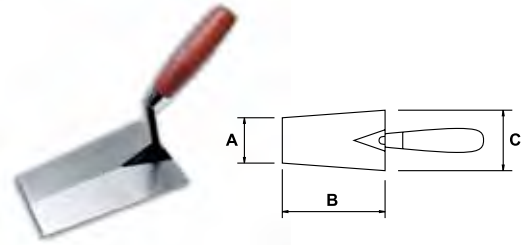

MOD. CATALÁN

COD	A	B	gr.		
67006	115	160	310	6	1
67005	122	170	320		

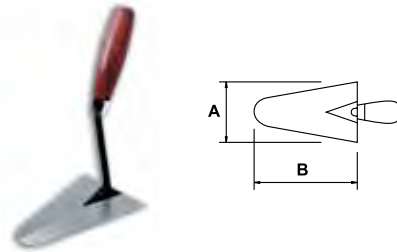

MOD. MADRID

COD	A	B	gr.		
67007	70	150	150	6	1
67008	85	165	175		
67009	95	180	200		
67010	105	200	245		
67019	115	230	290		

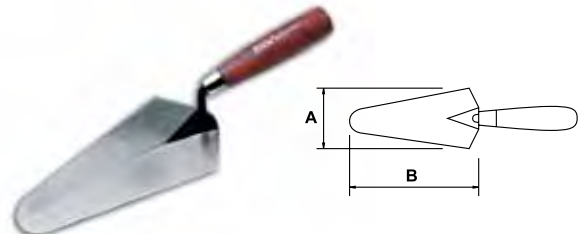

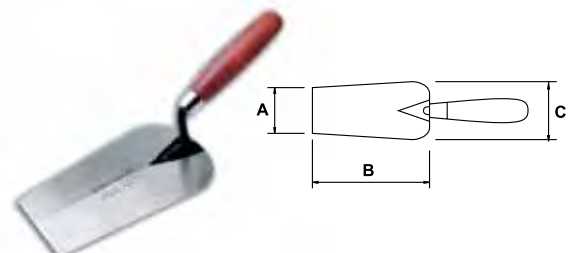

MOD. SEVILLA

COD	A	B	C	gr.		
67011	85	190	112	320	6	1



22 CONSTRUCCIÓN / CONSTRUCTION / CONSTRUCTION / BAUWESEN / COSTRUZIONI / CONSTRUÇÃO / СТРОИТЕЛЬСТВО

MOD. ARABIA

COD	A	B	C	gr.		
67100	44	180	95	210	6	1
67101	50	200	110	250		

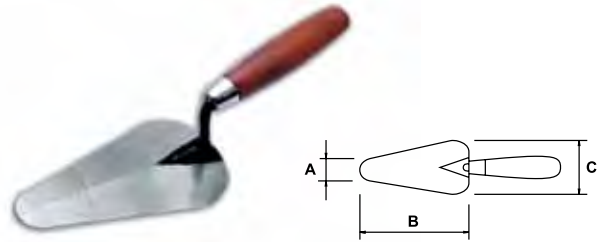



MOD. ALICATADOR

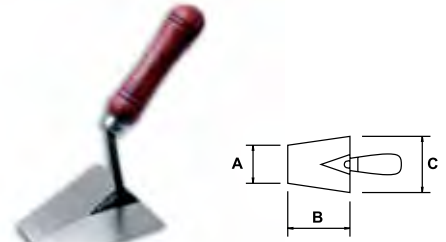

COD	A	B	C	gr.		
67012	65	120	120	280	6	1

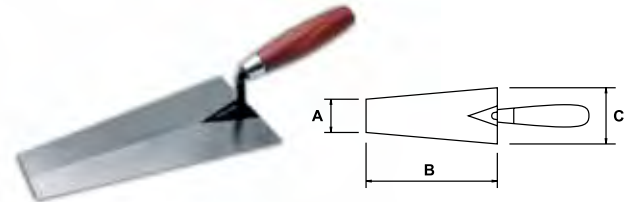

MOD. PORTUGAL

COD	A	B	C	gr.		
67013	65	250	130	280	6	1



COD	A	B	C	gr.		
67015	56	220	120	390	6	1
67014	60	250	130	480		

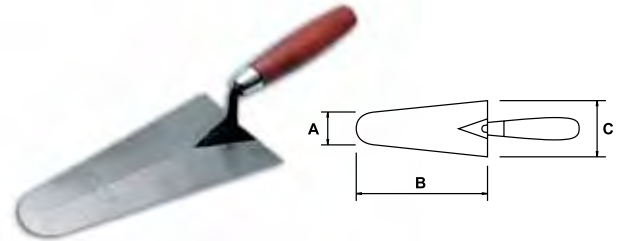

COD	A	B	gr.		
67016	150	300	500	5	1

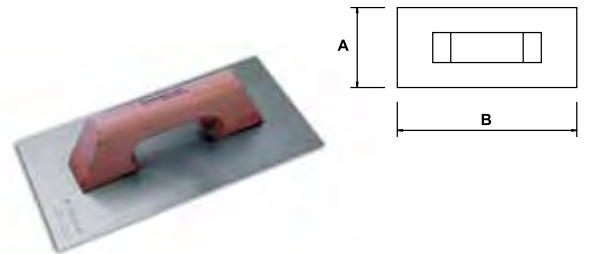

COD	A	B	gr.		
67018	115	275	400	5	1

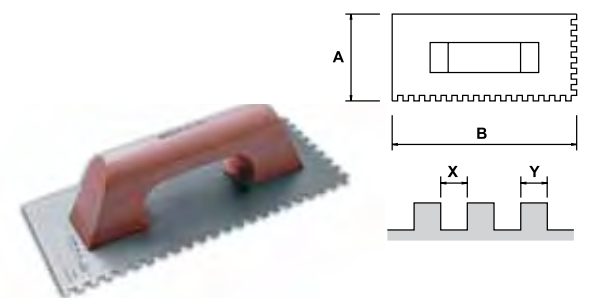

22

CONSTRUCCIÓN / CONSTRUCTION / CONSTRUCTION / BAUWESEN / COSTRUZIONI / CONSTRUÇÃO / СТРОИТЕЛЬСТВО

COD	A	B	gr.		
67020	30	230	65	12	1
67021	40				
67022	50				
67023	60	235	75	12	1
67024	70				
67025	80	240	85	12	1
67026	90				
67027	100	250	90	12	1

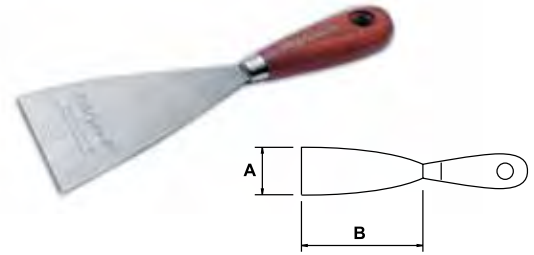

KIT 64 PCS.

COD	L mm	PCS.
67029	30	8
	40	
	50	
	60	
	70	
	80	
	90	
	100	



PALANCA BOCA CURVA / PRY BAR / PINCE À TALON COURBE / BRECHSTANGE, GESCHLOSSER / LEVA
UNGHIA CHIUSA / ALAVANCA BOCA CURVA / КРИУК

COD	size	L mm	Kg.	
67202	6"	150	0,1	6
67203	12"	300	0,2	
67204	16"	405	0,5	
67205	20"	490	0,8	



Composición / Composition

67206	67202, 67203, 67204, 67205	1.6	1
-------	----------------------------	-----	---

PALANCA DE ENCOFRADOR / WRECKING BAR / PINCE À DECOFFRER / NAGELEISEN / LEVERING
CARPENTIERE / ALAVANCAS DE ENCOFRADOR / МОТИРОВАКА

COD	L	mm	gr.
63261	12"	14	250
63262	18"	16	700
63263	24"		
63264	30"	18	2000
63265	36"		
63266	42"	19	2750
63267	48"		



22 CONSTRUCCIÓN / CONSTRUCTION / CONSTRUCTION / BAUWESEN COSTRUZIONI / CONSTRUÇÃO / СТРОИТЕЛЬСТВО

PERFORADORAS / DRILLS / CAROTTEUSE À BETON / BOHRGERÄTE / PERFORATORE
PERFURADORAS / КОРОНКИ

PERFOMATIC - 80

COD	CAP Ø	W	V	* R	R.P.M.	Kg.
60226	12-80	1500	230	1/2" BSP	950-2100	7,5
60227			110	1.1/4" UNC		

* 1/2": Hembra / Female / Femelle - 1.1/4": Macho / Male / Male

SSR: Sistema de arranque suave / Soft start system / Système doux de démarrage



CE *G12

PERFOMATIC - 102

COD	CAP Ø	W	V	* R	R.P.M.	Kg.
60228	12-102	1500	230	1/2" BSP	950-2100	22
60229			110	1.1/4" UNC		

* 1/2": Hembra / Female / Femelle - 1.1/4": Macho / Male / Male

SSR: Sistema de arranque suave / Soft start system / Système doux de démarrage

PRCD: Incluido / Included / Inclue

(Para evitar picos de tensión / To avoid voltage picks / Pour éviter des pics de tension)



CE *G12

PERFOMATIC - 205

COD	CAP Ø	W	V	* R	R.P.M.	L	⌋	⌋	⌋	Kg.
60230	12-205	2400	230	1/2" BSP 1.1/4" UNC	600	●				41
60231							●			
60232							●	●		
60233							●	●		
60234							●	●	●	
60235								●	●	
60236						110		●	●	
60237				●	●	●				

* 1/2": Hembra / Female / Femelle - 1.1/4": Macho / Male / Male

PRCD: Incluido / Included / Inclue

(Para evitar picos de tensión / To avoid voltage picks / Pour éviter des pics de tension)

⌋ Soporte fijo / Fixed bracket / Support fixe

⌋ Soporte reclinable 90° / 90° reclinable bracket / Support inclinable 90°

⌋ Ventosa / Vacuum base / Ventouse



CE *G12

22

CONSTRUCCIÓN / CONSTRUCTION / CONSTRUCTION / BAUWESEN / COSTRUZIONI / CONSTRUCCÃO / СТРОИТЕЛЬСТВО

PERFORADORAS / DRILLS / CAROTTEUSE À BETON / BOHRGERÄTE / PERFORATORE /
PERFURADORAS / КОРОНКИ
PERFORMATIC - 255

COD	CAP. Ø	W	V	* R	R.P.M.	L	L	Ø	Kg.	
60238	12-255	2600	230	1/2" BSP 1.1/4" UNC	460-900	●			45	
60239						●	●			
60240						●		●		
60241						●		●		
60242			●				●			
60243			●			●				
60244			●				●			
60245			●			●	●			

PERFORMATIC - 300

COD	CAP. Ø	W	V	* R	R.P.M.	L	L	Ø	Kg.	
60246	12-300	3300	230	1/2" BSP 1.1/4" UNC	460-900	●			50	
60247						●	●			
60248						●		●		
60249						●		●		
60250			●				●			
60251			●			●				
60252			●				●			
60253			●			●	●			

* 1/2": Hembra / Female / Femelle -1.1/4": Macho / Male / Male

PRCD: Incluido / Included / Includ

(Para evitar picos de tensión / To avoid voltage picks / Pour éviter des pics de tension)

BROCA DE HORMIGÓN, SEGMENTOS DE DIAMANTE SINTERIZADOS / SINTERED DIAMOND DRILLS FOR REINFORCED
CONCRETE DRILLS / COURONNES AVEC INTEGRATION DES SEGMENTS DIAMANTES POUR LE FORAGE DE BETONS
ARMES / DIAMANT-BOHRKRONEN FÜR STAHL UND BETON / CORONA PER CEMENTO ARMATO, PUNTA DIAMANTATA
SINTERIZZATA / BROCA PARA CIMENTO ARMADO, SEGMENTOS DE DIAMANTE SINTERIZADOS /
АЛМАЗНЫЕ КОРОНКИ ДЛЯ СВЕРЛЕНИЯ ЖЕЛЕЗОБЕТОНА

PARA CORTE HÚMEDO / FOR WET CUT / FORAGE À LEAU / ZUM NASSBOHREN / PER TAGLIO AD ACQUA / PARA
CORTE HUMIDO / ДЛЯ МОКРОГО СВЕРЛЕНИЯ

COD A	Ø x L	R	COD B	Ø x L	R
64366	32x360	1.1/4" UNC HEMBRA FEMALE	64355	12x120	1/2" BSP MACHO MALE
64367	44x360		64356	18x220	
64368	53x360		64357	26x320	
64369	63x360		64358	32x320	
64370	71x360		64359	44x320	
64371	83x360		64360	53x320	
64372	89x360		64361	63x320	
64373	102x360		64362	71x320	
64374	110x360		64363	83x320	
64375	120x360		64364	89x320	
64376	127x360		64365	102x320	
64377	132x360				
64378	150x360				
64379	159x360				
64380	166x360				
64381	180x360				
64382	202x360				
64383	220x360				
64384	244x360				
64385	300x360				



PARA CORTE SECO / FOR DRY CUT / FORAGE À SEC / ZUM TROCKENBOHREN / PER TAGLIO ASCIUTO / PARA
CORTE SECO / ДЛЯ СУХОГО СВЕРЛЕНИЯ

COD	Ø x L	R
64386	32x300	1/2" BSP MACHO MALE
64387	44x300	
64388	53x300	
64389	63x300	
64390	71x300	
64391	83x300	
64392	89x300	
64393	102x300	
64394	110x300	
64395	120x300	
64396	132x300	
64397	150x300	



CE *G12

22 CONSTRUCCIÓN / CONSTRUCTION / CONSTRUCTION / BAUWESEN / COSTRUZIONI / CONSTRUÇÃO / СТРОИТЕЛЬСТВО

SOPORTE FIJO / FIXED BRACKET / SUPPORT FIXE / STÄNDER / SUPPORTO FISSO / SUPORTE FIXO / СТАНИНА ДЛЯ СВЕРЛЕНИЯ

COD		Kg.
64398	PERFOMATIC-205	22
	PERFOMATIC-255	
	PERFOMATIC-300	



SOPORTE RECLINABLE 90° / 90° RECLINABLE BRACKET / SUPPORT INCLINABLE 90° / STÄNDER 90° SCHWENKBAR / SUPPORTO INCLINABILE 90° / SUPORTE INCLINAVEL 90° / СТАНИНА ДЛЯ СВЕРЛЕНИЯ ПОД УГЛОМ

COD		Kg.
64399	PERFOMATIC-205	35
	PERFOMATIC-255	
	PERFOMATIC-300	



VENTOSA / VACUUM BASE / VENTOUSE / VAKUUMPLATTE / VENTOSA / VENTOSA / ВАКУУМНАЯ ПЛИТА

COD				Kg.
64400	PERFOMATIC-205	64409		6,5
	PERFOMATIC-255			
	PERFOMATIC-300			



EXTENSIÓN / EXTENSION / EXTENSION / VERLÄNGERUNG / ESTENSORE / EXTENÇÃO / УДЛИНИТЕЛЬ

COD	A-B	Ø x L	Kg.
64406	1.1/4" UNC	40x150	1,0
64407		40x210	1,3
64414	1/2" BSP	30x200	0,8
64415		30x260	1,1



MANGO / HANDLE / MANCHE / GRIFF / MANICO / PUNHO / РУКОЯТКА

COD		Kg.
64408	PERFOMATIC-80	0,7
	PERFOMATIC-102	



CONECTOR ADAPTADOR ROSCA / THREAD CONNECTION ADAPTOR / CONNECTEUR ADAPTATEUR DE FILETAGE / ADAPTOR VERBINDUNGSADAPTER FÜR GEWINDE / ADATTATORE CONNETTORE PER FILIERA / ADAPTADOR DE ROSCA / РЕЗЬБОВОЙ ПЕРЕХОДНИК

COD		A-B	Kg.
64426	*	1.1/4" UNC - 1/2" BSP	0,4

* Hembra / Female / Femelle - Hembra / Female / Femelle

COD		A-B	Kg.
64610	*	1.1/4" UNC - 1/2" BSP	0,4

* Hembra / Female / Femelle - Macho / Male / Male



22

CONSTRUCCIÓN / CONSTRUCTION / CONSTRUCTION / BAUWESEN / COSTRUZIONI / CONSTRUÇÃO / СТРОИТЕЛЬСТВО

MÁQUINAS DE CORTE / CUTTING MACHINES / MACHINES DE COUPE / SCHNEIDMASCHINEN /
MACCHINE DA TAGLIO / MACCHINA TAGLIATRICE / МАШИНЫ ДЛЯ РУБКИ АРМАТУРЫ

CORTAVARILLAS ELECTROHIDRÁULICO / ELECTROHYDRAULIC REBAR CUTTERS / COUPE BOULON ELECTRO-
HYDRAULIQUE / ELEKTRO-HYDRAULISCHER STAHLDRANTSCHNEIDER / TAGLIABULLONI ELETTRICO /
TESOURA CORTA VARÃO ELECTRO HIDRAULICA / ЭЛЕКТРОГИДРАВЛИЧЕСКИЕ РУБИКИ АРМАТУРЫ

REBARMATIC - 16 PORTABLE

COD	V	CAP	W		
60274	110-240V	Ø4-Ø16mm	690	64692	5,6

Especificaciones técnicas / Technical specification / Détails techniques	
Capacidad / Capacity / Capacité	4mm-16mm
Velocidad de corte / Cutting speed / Vitesse de coupe	3 sg (16mm)
Cabezal giratorio / Revolving head / Tête pivotante	360°
Batería / Battery / Piles	Ni-Mh DC 18V 3Ah
Baterías incluidas / Included batteries / Piles incluses	2 pcs
Sistema electrohídrico / Electrohydraulic system / Système electrohydraulique	●
Tamaño estuche / Case dimensions / Dimension de l'étui	415x390x135mm
Estuche metálico / Metallic case / Etui métallique	●
Juego cuchillas / Blade set / Jeu de couteaux	64692

**REBARMATIC - 16**

COD	V	CAP	W		
60270	230	Ø4-Ø16mm	690	64177	8
60272	110				

Especificaciones técnicas / Technical specification / Détails techniques	
Capacidad / Capacity / Capacité	4mm-16mm
Velocidad de corte / Cutting speed / Vitesse de coupe	3 sg (16mm)
Sistema electrohídrico / Electrohydraulic system / Système electrohydraulique	●
Tamaño estuche / Case dimensions / Dimension de l'étui	460x150x115mm
Estuche metálico / Metallic case / Etui métallique	●
Juego cuchillas / Blade set / Jeu de couteaux	64177

**REBARMATIC - 22**

COD	V	CAP	W		
60271	230	Ø4-Ø22mm	850	64178	12
60273	110				

Especificaciones técnicas / Technical specification / Détails techniques	
Capacidad / Capacity / Capacité	4mm-22mm
Velocidad de corte / Cutting speed / Vitesse de coupe	3 sg (22mm)
Sistema electrohídrico / Electrohydraulic system / Système electrohydraulique	●
Tamaño estuche / Case dimensions / Dimension de l'étui	420x130x150mm
Estuche metálico / Metallic case / Etui métallique	●
Juego cuchillas / Blade set / Jeu de couteaux	64178



ÁNTES / BEFORE / AVANT



DESPUÉS / AFTER / APRÈS



NATO Commercial and Government Entity (NCAGE) Code / Código (NCAGE) OTAN: 8552B



381

22 CONSTRUCCIÓN / CONSTRUCTION / CONSTRUCTION / BAUWESEN / COSTRUZIONI / CONSTRUÇÃO / СТРОИТЕЛЬСТВО

TRONZADORA DISCO ABRASIVO / CUT-OFF MACHINE / MEULEUSE À DISQUES ABRASIFS /
TRENNSCHLEIFMASCHINE / MACCHINA DA TAGLIO / CORTADORA DE DISCO ABRASIVO / АБРАЗИВНАЯ ПИЛА

COD	Ø	V	W	R.P.M.	Kg.	
60254	355	230	2300	3900	19	85118
60255		110				



SIERRA PARA LADRILLOS CON MESA / BENCH BRICKS CUT-OFF MACHINE / SCIE À BRIQUES AVEC TABLE /
TISCHKREISSÄGE FÜR BACKSTEIN / MACCHINA DA TAGLIO CON BANCO / SERRA PARA CORTAR MOSAICOS
CON MESA / НАСТОЛЬНАЯ ПИЛА ДЛЯ КИРПИЧА

COD	Ø	CAP	V	W	R.P.M.	Kg.
60256	355	255x406x127	230	1650	3500	21
60257			110			

REFRIGERADA POR AGUA / WATER-COOLED / REFROIDISEUR D'EAU / WASSERKÜHLED
ACQUA REFFRIGERATA / WATERGEKOELD / DE REFRIGERAÇÃO POR AGUA
С ВОДЯНЫМ ОХЛАЖДЕНИЕМ



SIERRA PARA LADRILLOS / BRICKS CUT-OFF SAW / SCIE À BRIQUES / KREISSÄGE FÜR BACKSTEIN /
MACCHINA DA TAGLIO / SERRA PARA CORTAR MOSAICOS / ПИЛА ДЛЯ ОТРЕЗКИ КИРПИЧЕЙ

COD	Ø	CAP	V	W	R.P.M.	Kg.
60258	355	255x406x127	230	1650	3500	11
60259			110			

REFRIGERADA POR AGUA / WATER-COOLED / REFROIDISEUR D'EAU / WASSERKÜHLED
ACQUA REFFRIGERATA / WATERGEKOELD / DE REFRIGERAÇÃO POR AGUA
С ВОДЯНЫМ ОХЛАЖДЕНИЕМ

