

SPECIAL SELECTION **IKO**

VOL.2

*New models are introduced!
Wide range of variations!*

LWL

Linear Way L

CAT-57116

U.S. PATENTED



Further evolution

*"Miniature Type Linear Way" series meeting
the next-generation needs.
World-smallest size model with a track rail width of 2 mm
has been introduced!*



IKO Linear Way L LWL, LWLF



Very small size Linear Way realized by

IKO Linear Way L is a miniature type linear motion rolling guide, incorporating two rows of steel balls arranged in four-point contact with the raceways. Owing to its simple design, it provides stable accuracy and rigidity even in operations under fluctuating loads with changing direction and magnitude or complex loads.

The standard products are made of stainless steel, and a wide range of variations in shapes and sizes are available for selection suitable for each application.

Linear Way L is widely used in such fields as medical equipment, semiconductor manufacturing equipment, and liquid crystal related equipment, where its excellent performance has been proved.

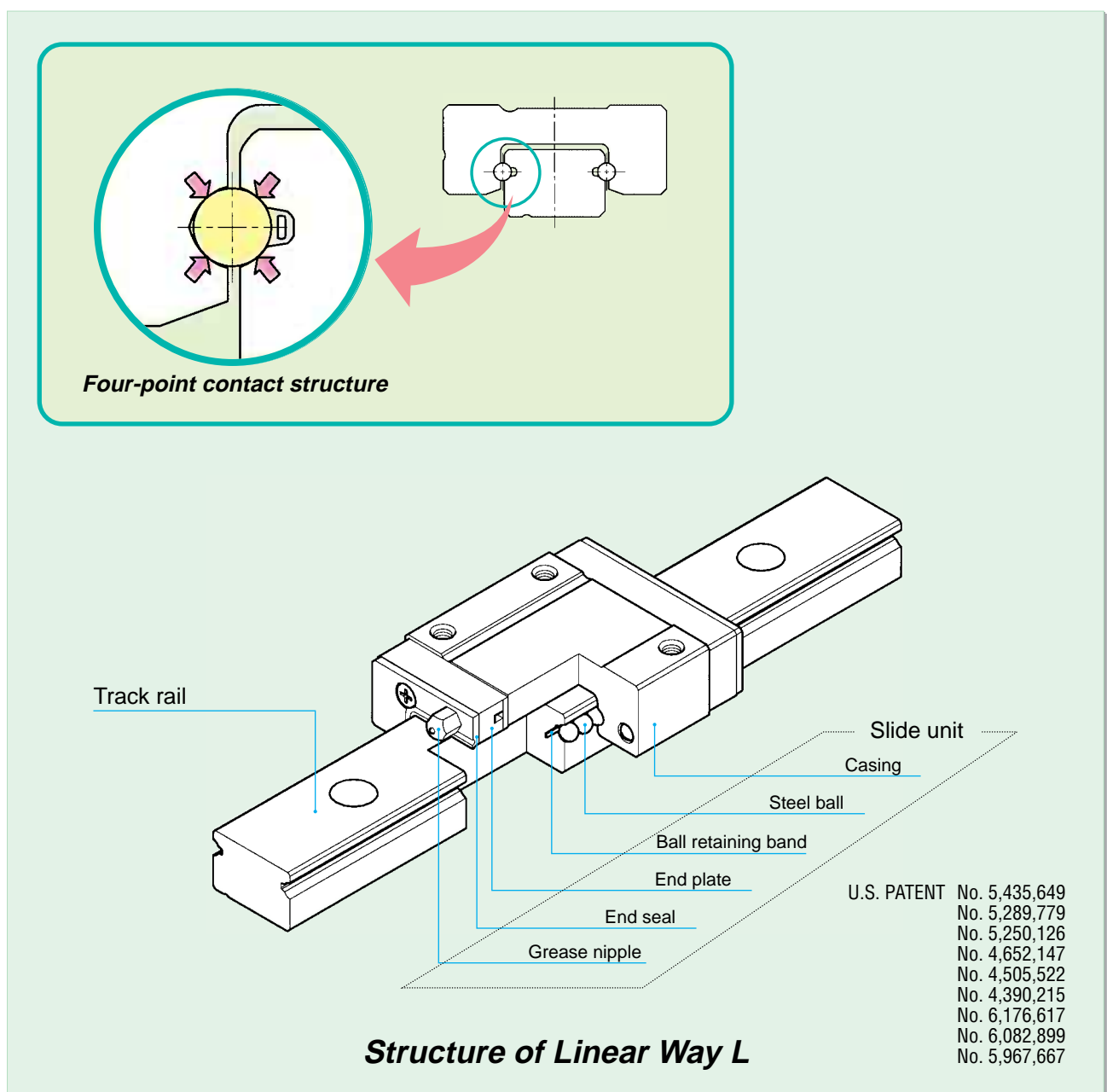

adopting a two-row simple structure

Miniature size

The smallest size models, Linear Way LWL 2 (track rail width: 2 mm) and Linear Way LWLF 4 (wide rail type) have been newly added to the series. These models will contribute to further reduction in size and weight and improvement in performance of equipment.

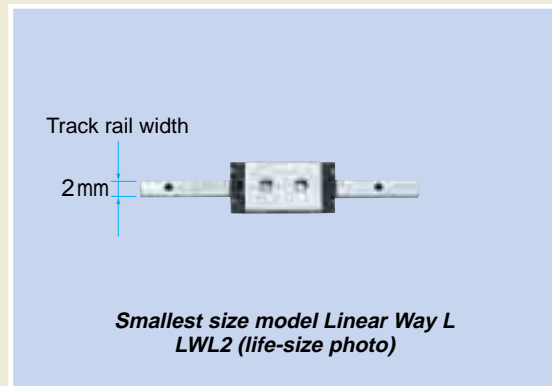

High accuracy achieved by eliminating the number of potential errors

The simple two-row, four-point contact design minimizes the number of potential errors in manufacturing and measurement, so the highest level of dimensional accuracy between rows can be achieved. Interchangeable specification products of high-interchangeability level can be manufactured benefiting from this feature by rigorous control of the dimensional accuracy of individual slide units and track rails.

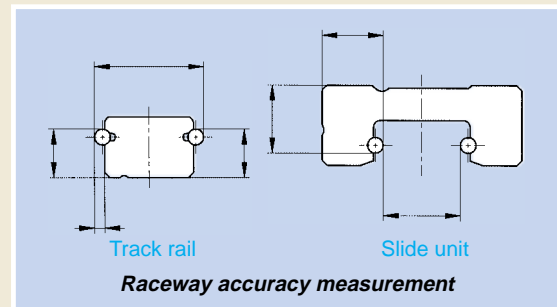

Stainless steel series with excellent corrosion resistance

Stainless steel series Linear Way L has excellent corrosion resistance and is most suitable for machines and equipment used in clean rooms and environments, for example, medical equipment, disk read devices, and semiconductor manufacturing equipment.

Ball retained type realized in miniature series

The slide unit of ball retained type incorporates ball retaining bands, which prevent steel balls from dropping when the slide unit is separated from the track rail. So mounting on machines and equipment can be made easily.

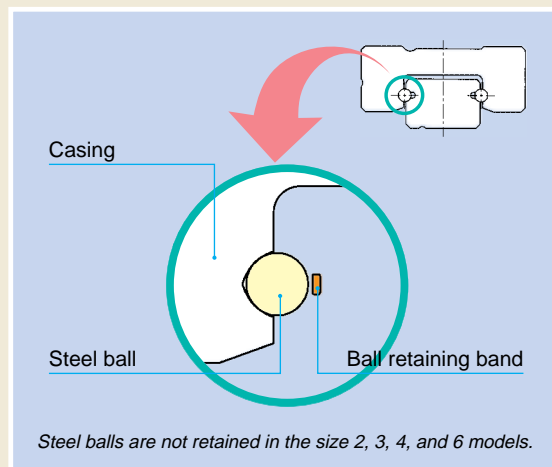

Abundant variations

Two types with different section shapes, the standard type and the wide rail type, are available. In each of these types, three types with different lengths are also provided. The wide rail type can support a large moment load acting around the axial direction, and is suitable for single row rail arrangement.

In addition to the standard specification track rail which is fixed by inserting bolts downward in the mounting holes, the tapped rail specification track rail that has tapped screw holes is available, so an optimum mounting direction can be selected, giving more freedom in machine design.

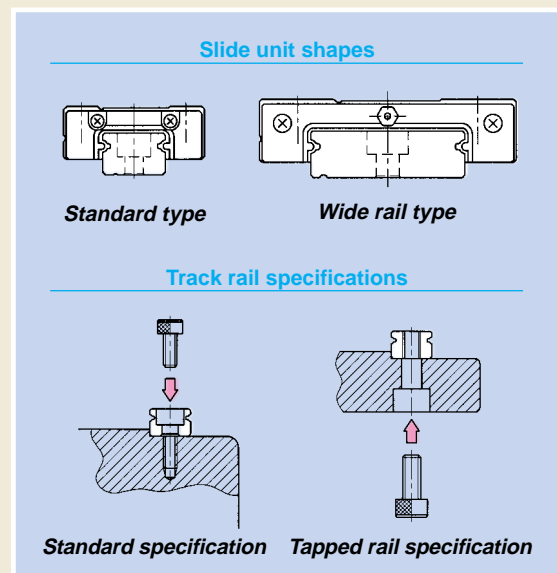

Stainless Steel Series for Special Environment

Stainless steel series Linear Way L, which is more resistant to corrosion than the high carbon steel models, is most suitable for applications in clean rooms and in places where the use of rust preventive oil must be limited or avoided because any oily content is inimical to the environment. Product specifications most suitable for the needs in diversified special environment applications can be provided by combining various special specifications.

Stainless steel end plate

By replacing the standard synthetic resin end plates with stainless steel end plates, Linear Way L can be used in a vacuum environment and its heat resistance can be improved as well. When ordering, indicate this specification in combination with the specification of "with no end seals" (supplemental code "/N") or the specification of "with seals for special environment" (supplemental code "/RE").

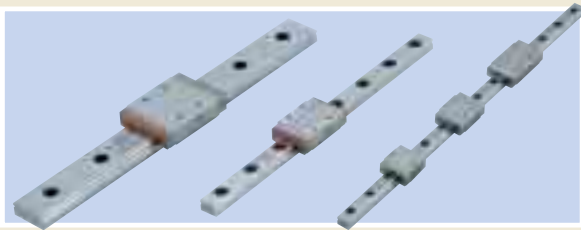

Low-dust-generation grease CG2 for clean environment

When Linear Way L is used in a clean environment, pollution of the clean environment by scattered grease must be avoided.

The low-dust-generation grease for clean environment, which contains the urea base thickener and synthetic base oil, keeps the environmental pollution in clean rooms to the lowest level.



<Identification number> TG120/CG2 (Tube type: Net 120 g)



<Identification number> MG10/CG2 (Miniature greaser type: Net 10 g)

Interchangeable Products, Three Features of Interchangeability

The track rails and the slide units of interchangeable specification Linear Way L can be handled separately and can be assembled to make a set as required. Interchangeability of incomparable high level has been achieved through rigorous dimensional control of the slides units and the track rails on the basis of the original advanced manufacturing technology of IJK.

Interchangeable slide unit

Three types of slide units with different lengths are prepared. All of these slide units can be freely mounted on the same track rail.

It is also possible to combine a slide unit and track rail of different materials, for example, a high carbon steel slide unit and stainless steel track rail can be combined.

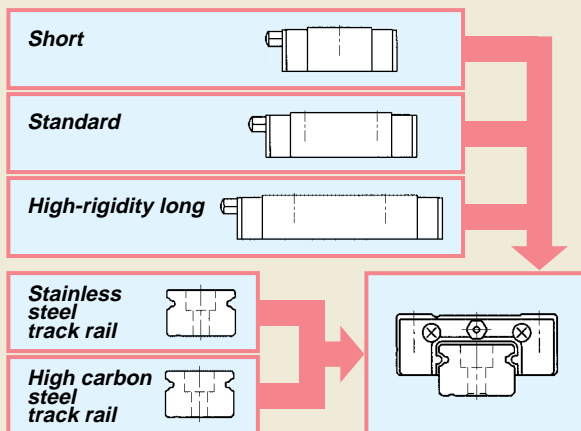

Interchangeable with high accuracy

Two accuracy classes, high class and precision class, are prepared as accuracy classes to satisfy the requirement for high running accuracy. Height variation among multiple sets is also controlled at a high accuracy level, ensuring that these products can be used for parallel track rail arrangement.

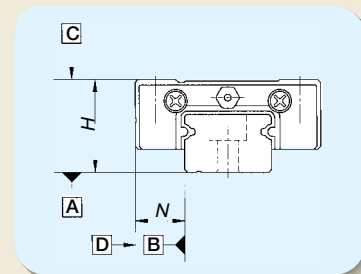

Interchangeable with preload

High accuracy dimensional control owing to a simple structure has made it possible to realize the interchangeability among preloaded slide units. These products can be used for applications requiring one step higher rigidity.

Various Types for Diversified Application Needs

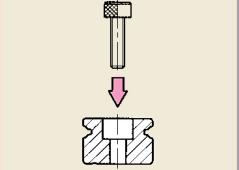
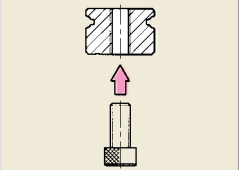
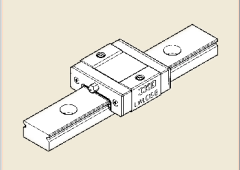
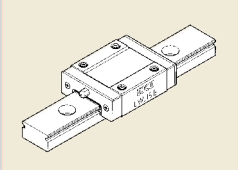
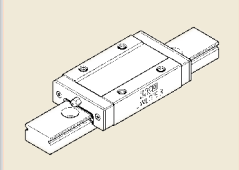
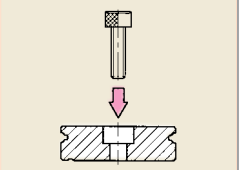
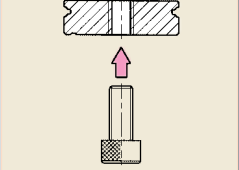
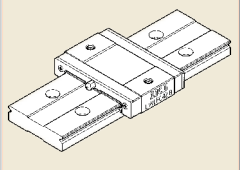
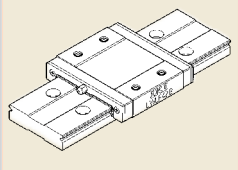
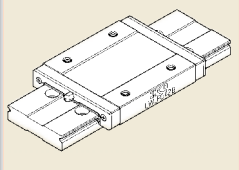
| Shape | Track rail specification | | Length of slide unit | | |
|----------------|---|---|---|--|---|
| | Standard specification | Tapped rail specification | Short | Standard | High-rigidity long |
| Standard type |  |  |  |  |  |
| | LWL...B | LWL...N | LWLC | LWL | LWLG |
| Wide rail type |  |  |  |  |  |
| | LWLF...B | LWLF...N | LWLFC | LWLF | LWLFG |

Abundant Series and Size variations

| Shape | Material | Length of slide unit | Track rail specification | Model code | Size | | | | | | | | | |
|----------------|------------------------|----------------------|---------------------------|------------------------------|------|---|----|----|----|----|----|----|----|--|
| Standard type | Stainless steel made | Short | Standard specification | LWLC ...B | — | — | 5 | 7 | 9 | 12 | 15 | 20 | 25 | |
| | | | Tapped rail specification | LWLC ...N ⁽¹⁾⁽²⁾ | — | 3 | 5 | 7 | 9 | — | — | — | — | |
| | | Standard | Standard specification | LWL ...B | — | — | 5 | 7 | 9 | 12 | 15 | 20 | 25 | |
| | | | Tapped rail specification | LWL ...N ⁽¹⁾⁽²⁾ | 2 | 3 | 5 | 7 | 9 | — | — | — | — | |
| | | High-rigidity long | Standard specification | LWLG ...B | — | — | — | 7 | 9 | 12 | 15 | 20 | 25 | |
| | | | Tapped rail specification | LWLG ...N | — | — | — | 7 | 9 | — | — | — | — | |
| | High carbon steel made | Standard | Standard specification | LWL ...BCS | — | — | — | — | 9 | 12 | 15 | 20 | — | |
| Wide rail type | Stainless steel made | Short | Standard specification | LWLFC ...B ⁽¹⁾⁽³⁾ | — | 6 | 10 | 14 | 18 | 24 | 30 | 42 | | |
| | | | Tapped rail specification | LWLFC ...N ⁽¹⁾ | — | 6 | 10 | 14 | 18 | — | — | — | | |
| | | Standard | Standard specification | LWLF ...B ⁽¹⁾⁽³⁾ | 4 | 6 | 10 | 14 | 18 | 24 | 30 | 42 | | |
| | | | Tapped rail specification | LWLF ...N ⁽¹⁾ | — | 6 | 10 | 14 | 18 | — | — | — | | |
| | | High-rigidity long | Standard specification | LWLFG ...B | — | — | — | 14 | 18 | 24 | 30 | 42 | | |
| | | | Tapped rail specification | LWLFG ...N | — | — | — | 14 | 18 | — | — | — | | |
| | High carbon steel made | Standard | Standard specification | LWLF ...BCS | — | — | — | — | 18 | 24 | 30 | 42 | | |

Note⁽¹⁾ : Steel balls are not retained in the size 2, 3, 4, and 6 models.
 Note⁽²⁾ : The track rails of size 2 and 3 models are tapped rails, but "N" is not attached to their model codes.
 Note⁽³⁾ : For the size 4 and 6 models, "B" is not attached to their model codes.

Remark: Interchangeable specification products are available in the sizes indicated in .

Identification Number

The specification of Linear Way L is indicated by the identification number, which consists of a model code, a size, a part code, a material symbol, a preload symbol, a classification symbol, an interchangeable code, and any supplemental codes.

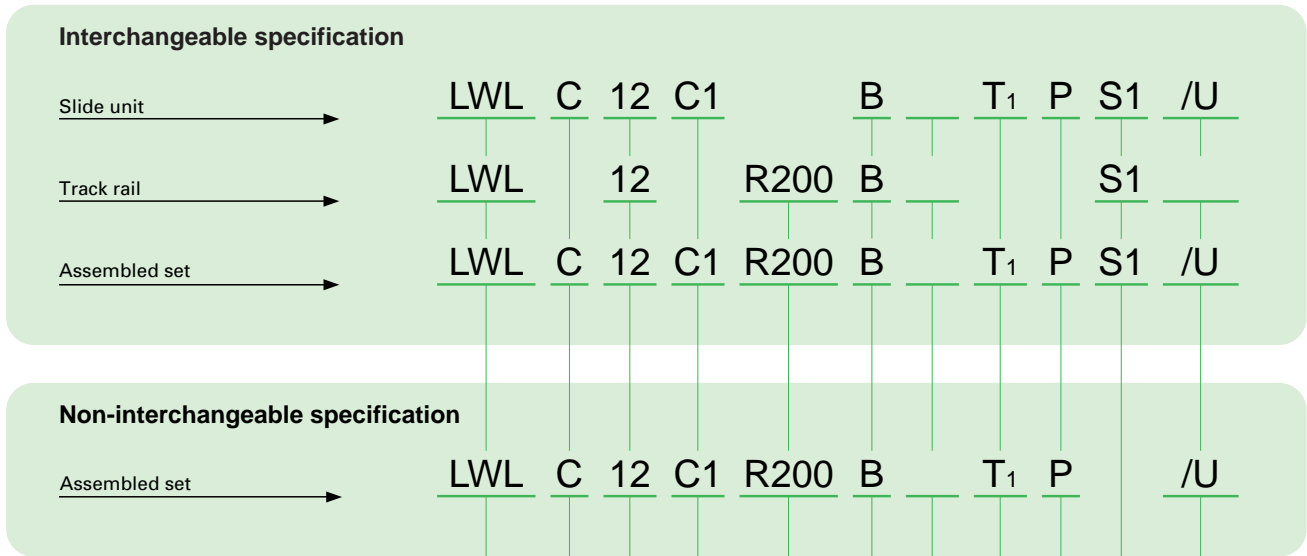

| | | | |
|--------------------------------|--|---------------------------|---|
| ① Series | Standard type Wide rail type | : LWL : LWLF | For applicable models and sizes, see Table 1. |
| ② Length of slide unit | Short Standard High-rigidity long | : C : No symbol : G | For applicable models and sizes, see Table 1. |
| ③ Structure | Ball non-retained type (sizes 2, 3, 4, and 6) Ball retained type (except sizes 2, 3, 4, and 6) Tapped rail specification | : No symbol : B : N | For applicable models and sizes, see Table 1. |
| ④ Size of rolling guide | | | For applicable models and sizes, see Table 1. |

Table 1 Models and sizes of Linear Way L

| LWL | Material | Model | Size | | | | | | | | | |
|------------------------|----------|-------|---------------------|---------------------|---|---|---|----|----|----|----|---|
| | | | 2 | 3 | 5 | 7 | 9 | 12 | 15 | 20 | 25 | |
| Stainless steel made | LWLC | LWLC | — | ○ ⁽¹⁾⁽²⁾ | ○ | ○ | ○ | ○ | ○ | ○ | ○ | ○ |
| | | LWL | ○ ⁽¹⁾⁽²⁾ | ○ ⁽¹⁾⁽²⁾ | ○ | ○ | ○ | ○ | ○ | ○ | ○ | ○ |
| | | LWLG | — | — | — | ○ | ○ | ○ | ○ | ○ | ○ | ○ |
| High carbon steel made | LWL...CS | — | — | — | — | ○ | ○ | ○ | ○ | ○ | — | |

| LWLF | Material | Model | Size | | | | | | | | | |
|------------------------|-----------|-------|------------------|------------------|----|----|----|----|----|----|---|--|
| | | | 4 | 6 | 10 | 14 | 18 | 24 | 30 | 42 | | |
| Stainless steel made | LWLF | LWLF | — | ○ ⁽¹⁾ | ○ | ○ | ○ | ○ | ○ | ○ | ○ | |
| | | LWLF | ○ ⁽¹⁾ | ○ ⁽¹⁾ | ○ | ○ | ○ | ○ | ○ | ○ | ○ | |
| | | LWLF | — | — | — | ○ | ○ | ○ | ○ | ○ | ○ | |
| High carbon steel made | LWLF...CS | — | — | — | — | ○ | ○ | ○ | ○ | ○ | | |

Note⁽¹⁾: In the size 2, 3, 4, and 6 models, steel balls are not retained. Interchangeable specification is not applicable to these models.

⁽²⁾: The track rails of the size 2 and 3 models are of the tapped rail specification, but "N" is not attached to the model code. The standard specification track rail is not available.

Remark: For the models indicated in , the tapped rail specification "N" is applicable. For Linear Way L of tapped rail specification, the interchangeable specification is not applicable.

| | | | |
|--------------------------------|--|---|--|
| ⑤ Number of slide units | Assembled set Slide unit | : C ○ : C1 | For an assembled set, the number of slide units assembled on one track rail is indicated. For a single slide unit, only "C1" can be indicated. |
| ⑥ Length of track rail | Assembled set Track rail | : R ○ : R ○ | The length of track rail is indicated in mm. For standard and maximum lengths, see Table 17 on pages 17 and 18. |
| ⑦ Material | Stainless steel made High carbon steel made | : No symbol : CS | For applicable models and sizes, see Table 1. |
| ⑧ Preload amount | Clearance Standard preload Light preload | : T ₀ : No symbol : T ₁ | Specify this item for an assembled set or a slide unit. Note that the preload amount that can be specified differs depending on the model and size. For details of preload amount, see Table 3 on page 9. |
| ⑨ Accuracy class | High class Precision class | : H : P | Specify this item for an assembled set or a single slide unit. The track rails of interchangeable specification are not classified by the classification symbol. For details of accuracy classes, see Table 2 on page 9. |
| ⑩ Interchangeable code | S1 specification S2 specification | : S1 : S2 | Specify this item for the interchangeable specification products. Assemble track rails and slide units with the same interchangeable code. Performance and accuracy of "S1" group and "S2" group are the same. |
| ⑪ Special specification | /A, /BS, /D, /E, /I, /LR, /N, /Q, /RE, /U, /W○, /Y○ | | For applicable special specifications, see Table 4 on page 10. |

Accuracy

The accuracy of Linear Way L is shown in Table 2.

Table 2 Accuracy

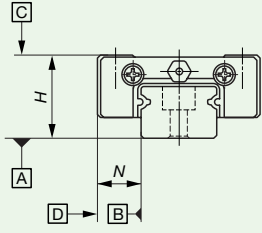

| Item | Classification (Symbol) | unit: mm | |
|--|-------------------------|-------------|---------------|
| | | High (H) | Precision (P) |
| Dim. H tolerance | | ± 0.020 | ± 0.010 |
| Dim. N tolerance | | ± 0.025 | ± 0.015 |
| Dim. variation of H ⁽¹⁾ | | 0.015 | 0.007 |
| Dim. variation of N ⁽¹⁾ | | 0.020 | 0.010 |
| Dim. variation of H for multiple assembled sets ⁽²⁾ | | 0.030 | 0.020 |
| Parallelism in operation of C to A | | See Fig. 1 | |
| Parallelism in operation of D to B | | See Fig. 1 | |

Note(1): It means the size variation between slide units mounted on the same track rail.
 (2): It applies to the interchangeable specification products.

Preload

The average amount of preload for Linear Way L is shown in Table 3.

Table 3 Preload amount

| Preload type | Item | Symbol | Preload amount (N) | Application |
|------------------------------|------|-------------|--------------------|---|
| Clearance ⁽¹⁾ | | T_0 | 0 ⁽⁴⁾ | · Very smooth motion |
| Standard ⁽²⁾ | | (No symbol) | 0 ⁽⁵⁾ | · Smooth and precise motion |
| Light preload ⁽³⁾ | | T_1 | $0.02C_0$ | · Minimum vibration · Load is equally balanced. · Smooth and precise motion |

Note(1): Applicable to the non-interchangeable specification.
 (2): Not applicable to the size 2, 3, 4, and 6 models.
 (3): Not applicable to the size 2, 3, 4, 5, 6, and 10 models.
 (4): Zero or minimal amount of clearance
 (5): Zero or minimal amount of preload
 Remark: C_0 means the basic static load rating.

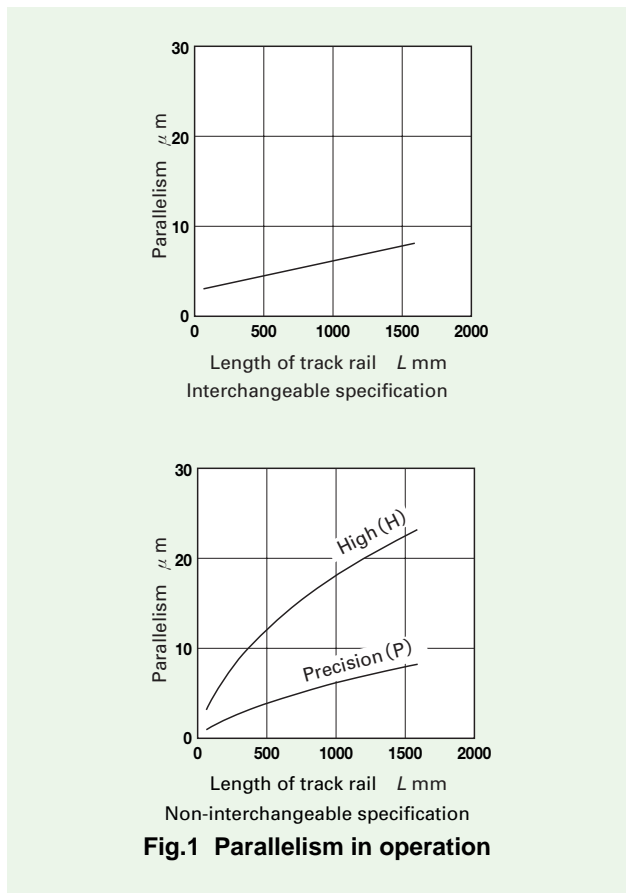

Special specifications

Linear Way L of the special specifications shown in Table 4 are available.

When a special specification is required, add the applicable supplemental code to the end of the identification number.

When a combination of several special specifications is required (See Table 5.), arrange their supplemental codes in alphabetical order.

Table 4 Special specifications for Linear Way L

| Special specification | Supplemental code | Interchangeable specification | | | Non-interchangeable specification |
|---|-------------------|-------------------------------|------------|------------------|-----------------------------------|
| | | Slide unit | Track rail | Assembled set | |
| Butt-jointing track rail | /A | — | — | — | ○ ⁽¹⁾⁽²⁾⁽³⁾ |
| Stainless steel end plates | /BS | — | — | — | ○ ⁽⁴⁾ |
| Opposite reference surfaces arrangement | /D | — | — | ○ | ○ |
| Specified track rail mounting hole positions | /E | — | ○ | ○ | ○ |
| Inspection sheet | /I | — | — | — | ○ |
| Black chrome surface treatment (track rail) | /LR | — | — | — | ○ ⁽²⁾⁽⁵⁾ |
| No end seal | /N | ○ | — | ○ | ○ ⁽³⁾ |
| Capillary plate | /Q | ○ | — | ○ | ○ ⁽³⁾ |
| Seal for special environment | /RE | — | — | — | ○ ⁽⁴⁾ |
| Track rail with stopper pins | /S | — | — | — | ○ ⁽³⁾ |
| Under seals | /U | ○ ⁽⁶⁾ | — | ○ ⁽⁶⁾ | ○ ⁽⁶⁾ |
| Matched sets to be used as an assembled group | /W○ | — | — | — | ○ |
| Specified grease | /Y○ | — | — | — | ○ |

- Note(1): Not applicable to the high carbon steel specification.
- (2): Not applicable to the tapped rail specification.
- (3): Not applicable to the size 2, 3, 4, and 6 models.
- (4): Not applicable to the size 2, 3, 4, 6, and 25 models.
- (5): Not applicable to the size 2, 3, 4, 5, 6, and 10 models.
- (6): Not applicable to the size 2, 3, 4, 5, 6, 7, 10, and 14 models.

Table 5 Combination of special specifications

| | | | | | | | | | | | | | |
|----|---|----|---|---|---|----|---|---|----|---|---|---|---|
| BS | ○ | | | | | | | | | | | | |
| D | ○ | ○ | | | | | | | | | | | |
| E | — | ○ | — | | | | | | | | | | |
| I | ○ | ○ | ○ | ○ | | | | | | | | | |
| LR | — | ○ | ○ | ○ | ○ | | | | | | | | |
| N | ○ | ○ | ○ | ○ | ○ | ○ | | | | | | | |
| Q | ○ | ○ | ○ | ○ | ○ | ○ | ○ | | | | | | |
| RE | ○ | ○ | ○ | ○ | ○ | ○ | — | ○ | | | | | |
| S | ○ | ○ | ○ | ○ | ○ | ○ | ○ | ○ | ○ | | | | |
| U | ○ | ○ | ○ | ○ | ○ | ○ | — | ○ | — | ○ | | | |
| W | ○ | ○ | ○ | — | ○ | ○ | ○ | ○ | ○ | ○ | ○ | | |
| Y | ○ | ○ | ○ | ○ | ○ | ○ | ○ | — | ○ | ○ | ○ | ○ | ○ |
| | A | BS | D | E | I | LR | N | Q | RE | S | U | W | |

Remark: The specifications marked ○ in this table can be combined.

Butt-jointing track rails /A

When the required length of stainless steel non-interchangeable specification track rail exceeds the maximum length shown in Table 17, two or more track rails can be used by butt-jointing them in the direction of linear motion. For the length and the number of butt-jointing track rails, consult for further information.

Opposite reference surfaces arrangement /D

The reference mounting surface of track rail is made opposite to the standard side. The accuracy of dimension N including parallelism in operation is the same with that of standard specification.

With stainless steel end plates /BS

The standard synthetic resin end plates are replaced with stainless steel end plates, keeping the total length of the slide unit unchanged. When superior heat resistance is required, it is recommended to apply this specification in combination with the "with seal for special environment (supplemental code /RE)" or "with no end seal (supplemental code /N)" specification.

Specified track rail mounting hole positions /E

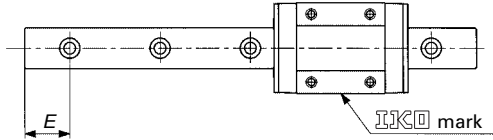

The mounting hole positions of track rail can be specified by specifying dimension E at the left end, which is the distance from the mounting hole nearest to the left end of the track rail to the left end face of the track rail in sight of IKKO mark on the slide unit. When ordering, add the dimension (in mm) after "/E". Dimension E can be specified in a limited range. Consult IKKO for further information.

Capillary plate /Q

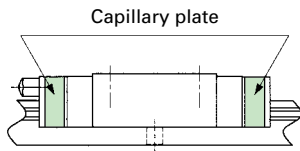

The capillary plate is assembled inside the end seal of the slide unit. It is impregnated with lubricant so that the re-lubrication interval can be made longer. For the total length of the slide unit with capillary plates see Table 6.

Track rail with stopper pins /S

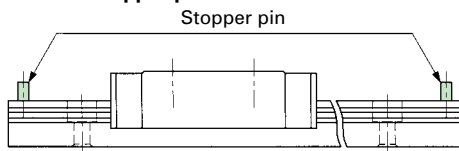

To prevent the slide unit of Linear Way L from slipping off, stopper pins are provided at both ends of the track rail. For dimensions of the track rail with stopper pins, see Table 7.

Specified grease /YCG /YBR /YNG

The type of prepacked grease in the slide unit can be changed by a supplemental code. The size 2 and 4 models are not applicable /YCG and /YBR specifications.

- ① /YCG IKKO low-dust-generation grease for clean environment CG2 is prepacked.
- ② /YBR MOLYCOTE BR2 Plus Grease (Dow Corning) is prepacked.
- ③ /YNG No grease is prepacked.

Inspection sheet /I

The inspection sheet recording dimensions H and N , dimensional variations of H and N , and parallelism in operation of the slide unit is attached to each set.

Black chrome surface treatment /LR

After a black permeable chrome film is formed on the track rail by treatment, acrylic resin is coated to improve the corrosion resistance.

No end seal /N

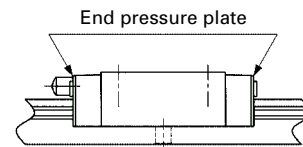

End seals at both ends of slide unit are replaced with end pressure plates that are not in contact with the track rail to reduce frictional resistance. The under seals are not assembled. This specification is not effective for dust protection.

Seal for special environment /RE

The standard end seals are changed into seals for special environment that can be used at high temperature.

With under seals /U

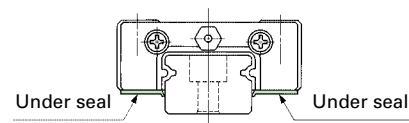

To prevent foreign substances from intruding from the lower side of Linear Way, seals are provided on the bottom faces of slide unit. For size H_1 , see Table 8.

Matched sets to be used as an assembled group /W

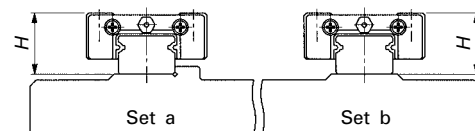

For two or more sets of Linear Way L used on the same plane, the dimensional variation of H of Linear Way L is kept within the specified range.

The dimensional variation of dimension H in matched sets is the same as that in a single set.

When ordering, indicate the number of sets, which is always represented by the number of track rails, after "/W".

**Table 6 Dimensions of slide unit with capillary plates
(Supplemental code: /Q)**

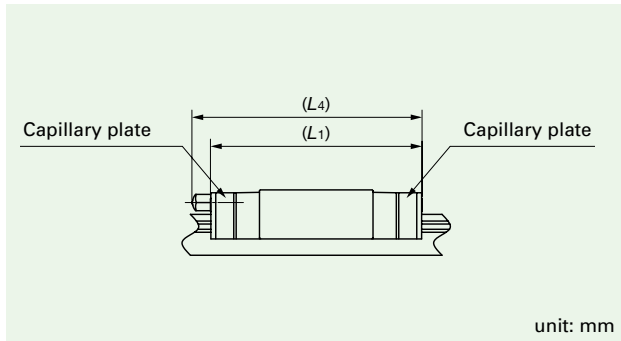

unit: mm

| Model number | L_1 | L_4 | Model number | L_1 | L_4 |
|--------------|-------|-------|--------------|-------|-------|
| LWLC 5...B | 22 | — | LWLFC 10...B | 26.5 | — |
| LWL 5...B | 25 | — | LWLF 10...B | 30.5 | — |
| LWLC 7...B | 27 | — | LWLFC 14...B | 30.5 | — |
| LWL 7...B | 31.5 | — | LWLF 14...B | 39.5 | — |
| LWLG 7...B | 39 | — | LWLFG 14...B | 50 | — |
| LWLC 9...B | 30 | — | LWLFC 18...B | 34.5 | — |
| LWL 9...B | 39 | — | LWLF 18...B | 47 | — |
| LWLG 9...B | 49 | — | LWLFG 18...B | 58.5 | — |
| LWLC 12...B | 33 | — | LWLFC 24...B | 38.5 | — |
| LWL 12...B | 42 | — | LWLF 24...B | 52 | — |
| LWLG 12...B | 52 | — | LWLFG 24...B | 67 | — |
| LWLC 15...B | 42 | 46 | LWLFC 30...B | 45.5 | 50 |
| LWL 15...B | 52 | 57 | LWLF 30...B | 60 | 64 |
| LWLG 15...B | 67 | 72 | LWLFG 30...B | 78.5 | 83 |
| LWLC 20...B | 48 | 52 | LWLFC 42...B | 51.5 | 56 |
| LWL 20...B | 60 | 65 | LWLF 42...B | 65 | 70 |
| LWLG 20...B | 78 | 82 | LWLFG 42...B | 84.5 | 89 |
| LWLC 25...B | 63.5 | 74 | | | |
| LWL 25...B | 87.5 | 98 | | | |
| LWLG 25...B | 107.5 | 118 | | | |

Remark: The above table shows representative model numbers but is applicable to all models of the same size.

**Table 7 Dimensions of track rail with stopper pins
(Supplemental code: /S)**

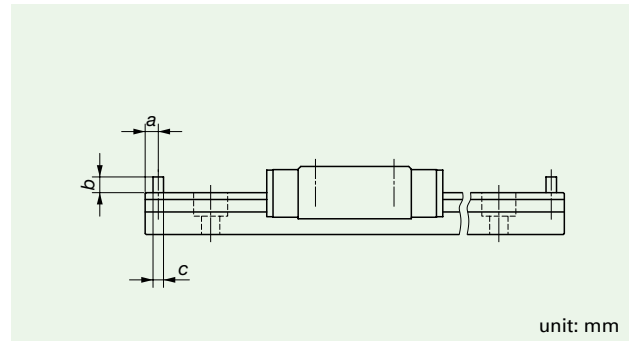

unit: mm

| Model number | a | b | c | Model number | a | b | c | | |
|--------------|-----|-----|-----|--------------|-----|-----|-----|-------------|---|
| LWL 5...B | 2 | 2 | 1.6 | LWLF 10...B | 2.5 | 2 | 1.6 | | |
| LWL 7...B | 2.5 | 2.5 | 2 | LWLF 14...B | | 3 | 2 | | |
| LWL 9...B | | 3 | | LWLF 18...B | | | | | |
| LWL 12...B | | 4 | | LWLF 24...B | | | | | |
| LWL 15...B | | 5 | | LWLF 30...B | | 4 | | | |
| LWL 20...B | | 3.5 | | 5 | | 2 | | LWLF 42...B | 5 |
| LWL 25...B | | | | | | | | | |

Remark: The above table shows representative model numbers but is applicable to all models of the same size. This table is not applicable to the interchangeable specification.

**Table 8 Dimension H_1 of slide unit with under seals
(Supplemental code: /U)**

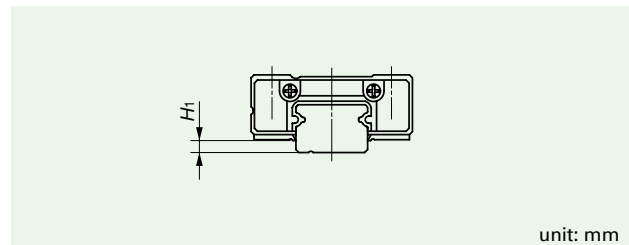

unit: mm

| Model number | H_1 | Model number | H_1 |
|--------------|------------------|--------------|-------|
| LWL 9...B | 1 | LWLF 18...B | 2 |
| LWL 12...B | 2 | LWLF 24...B | |
| LWL 15...B | 3 | LWLF 30...B | |
| LWL 20...B | 4 | LWLF 42...B | 3 |
| LWL 25...B | 5 ⁽¹⁾ | | |

Note(1): This dimension is the same as that without under seals.
Remark: The above table shows representative model numbers but is applicable to all models of the same size.

Load Rating and Life

Basic dynamic load rating C

The basic dynamic load rating is defined as the constant load in both direction and magnitude under which a group of identical Linear Ways are individually operated and 90% of those in the group can travel 50×10^3 meters free from material damage due to rolling contact fatigue.

Basic static load rating C_0

The basic static load rating is defined as the static load that gives a prescribed constant contact stress at the center of the contact area between the rolling element and raceway receiving the maximum load. It is the allowable limit load that permits normal rolling motion. Generally, the basic static load rating is used in combination with the static safety factor.

Static moment rating T_0, T_x, T_y

The static moment rating is defined as the static moment load that gives a prescribed constant contact stress at the center of the contact area between the rolling element and raceway receiving the maximum load when a moment (See Fig. 3.) is loaded. It is the allowable limit moment that permits normal rolling motion. Generally, the static moment rating is used in combination with the static safety factor.

Load direction and load rating

Since the load ratings of Linear Way L given in the table of dimensions are for upward/downward load, they must be corrected for the load direction for lateral load. The corrected

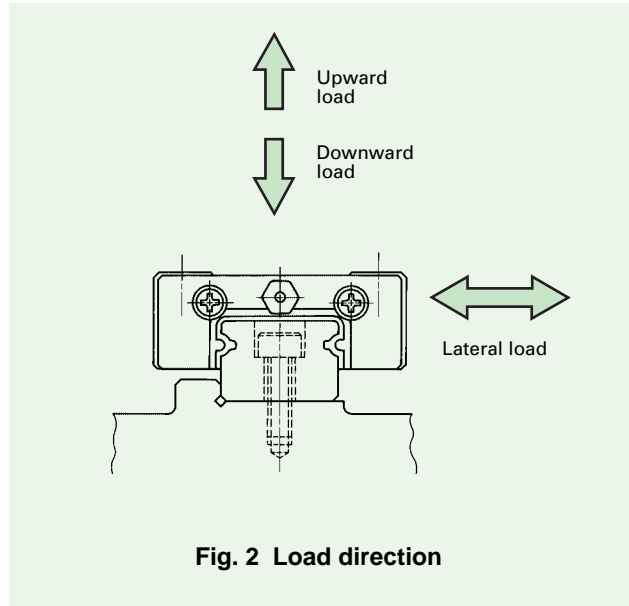

Fig. 2 Load direction

Table 9 Load ratings corrected for the load direction

| Load direction \ Size | Upward/downward direction | | Lateral direction | |
|-----------------------|---------------------------|-------------------|---------------------------|-------------------|
| | Basic dynamic load rating | Basic static load | Basic dynamic load rating | Basic static load |
| 2, 3, 4, 6 | C | C_0 | $1.13C$ | $1.19C_0$ |
| Other than 2, 3, 4, 6 | C | C_0 | $0.88C$ | $0.84C_0$ |

basic dynamic load ratings and basic static load ratings are shown in Table 9.

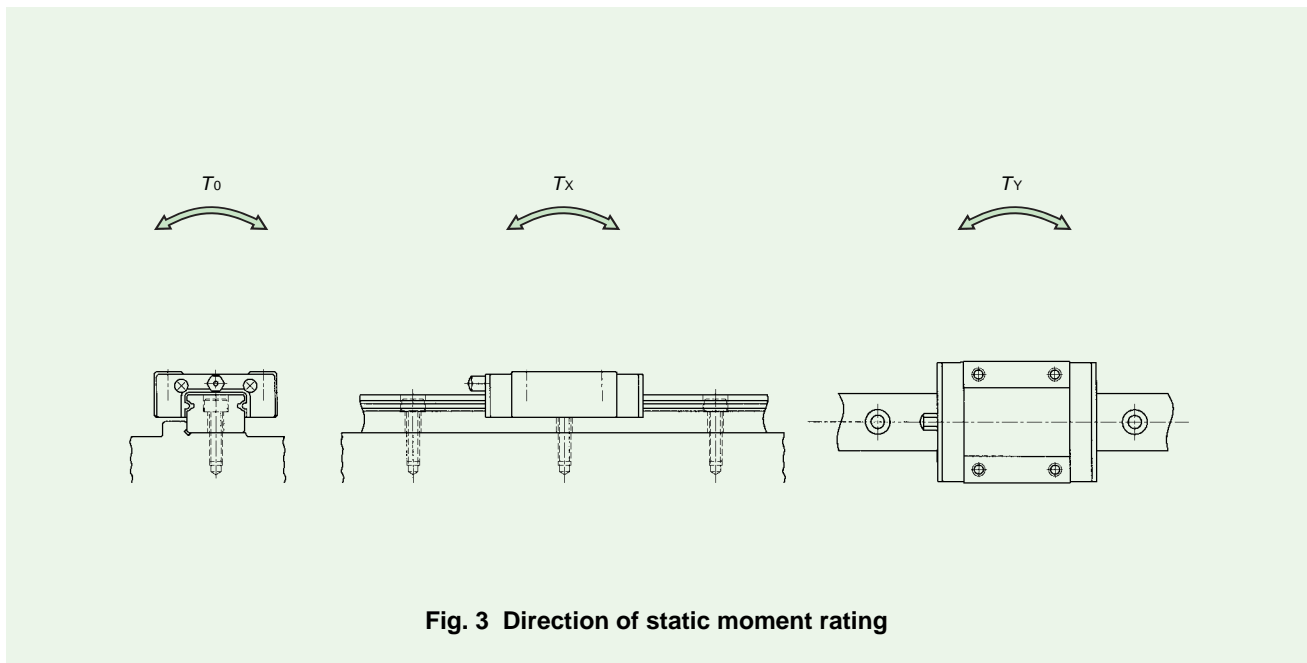

Fig. 3 Direction of static moment rating

Life

The rating life of Linear Way L can be calculated by the following formula.

$$L = 50 \left(\frac{C}{P} \right)^3 \dots\dots\dots(1)$$

where, L : Rating life, 10^3m
 C : Basic dynamic load rating, N
 P : Applied load, N

Accordingly, when the stroke length and the number of strokes per minute are given, the life in hours can be calculated from the following formula.

$$L_h = \frac{10^6 L}{2 S n_1 \times 60} \dots\dots\dots(2)$$

where, L_h : Rating life in hours, h
 S : Stroke length, mm
 n_1 : Number of strokes per minute, cpm

Static safety factor

The static safety factor of Linear Way L can be calculated by the following formula.

$$f_s = \frac{C_0}{P_0} \dots\dots\dots(3)$$

where, f_s : Static safety factor
 C_0 : Basic static load rating, N
 P_0 : Applied load (maximum load), N

Table 10 Static safety factor

| Operating conditions | f_s |
|--|-------|
| Operation with vibration and/or shocks | 3 ~ 5 |
| High operating performance | 2 ~ 4 |
| Normal operation | 1 ~ 3 |

Load factor

Due to vibration and/or shocks during machine operation, the actual load on each rolling guide becomes greater in many cases than the theoretically calculated load. The applied load is generally calculated by multiplying the theoretically calculated load by the load factor indicated in Table 11.

Table 11 Load factor

| Operating conditions | f_w |
|--|-----------|
| Smooth operation free from vibration and/or shocks | 1 ~ 1.2 |
| Normal operation | 1.2 ~ 1.5 |
| Operation with vibration and/or shocks | 1.5 ~ 3 |

Lithium-soap base grease (MULTEMP PS No.2 (KYODO YUSHI)) is pre-packed in Linear Way L. However, as the quality of any grease will gradually deteriorate as operating time passes, periodic relubrication is necessary. The relubrication interval varies depending on the operating conditions of the rolling guides. A six month interval is generally recommended, and, if the machine operation consists of reciprocating motions with many cycles and long strokes, relubrication every three months is recommended.

Linear Way L is provided with an oil hole shown in Table 12 or a grease nipple shown in Table 13. The size 2, 3, 4, and 6 models are not provided with an oil hole. For lubrication of these models, apply grease directly to the raceways of the track rail. Supply nozzles matching the size of grease nipples and special grease injectors (miniature greaser) matching the size of oil holes are available. For these parts for lubrication, consult  for further information.

The capillary plate of special specification (supplemental code "/Q") can be used to extend the relubrication interval and greatly reduce the maintenance work including grease-replenishment.

Table 12 Oil hole

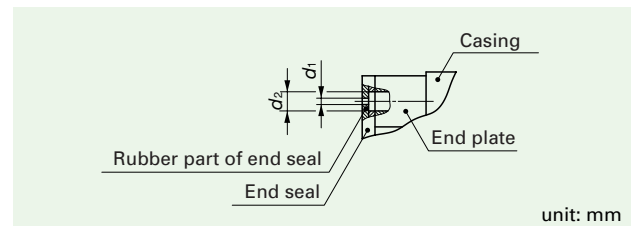

| Identification number | Oil hole size | |
|---------------------------|---------------|-------|
| | d_1 | d_2 |
| LWL 5...B LWLF 10...B | 0.5 | 1.1 |
| LWL 7...B LWLF 14...B | | 1.2 |
| LWL 9...B LWLF 18...B | | 1.5 |
| LWL 12...B LWLF 24...B | | 2 |

Remark: The above table shows representative model numbers but is applicable to all models of the same size.

Table 13 Grease nipple

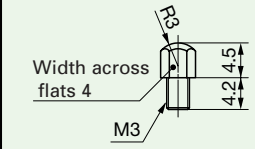
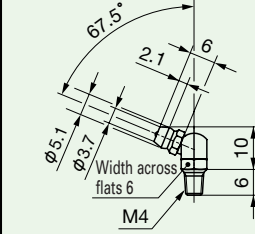
| Identification number | Type | Dimensions and shape |
|--|------|---|
| LWL 15...B LWLF 30...B LWL 20...B LWLF 42...B | A-M3 |  |
| LWL 25...B | B-M4 |  |



Remark: The above table shows representative model numbers but is applicable to all models of the same size.

Precautions for Use

1 Mounting surface, reference mounting surface, and general mounting structure

To mount Linear Way L, correctly fit the reference mounting surfaces B and D of the slide unit and the track rail to the reference mounting surfaces of the table and the bed, and then fix them tightly. (See Fig. 4.)

The reference mounting surfaces B and D and mounting surfaces A and C of Linear Way L are accurately finished by grinding. Stable and high accuracy linear motion can be obtained by finishing the mating mounting surfaces of machines or equipment with high accuracy and correctly mounting the guide on these surfaces.

The slide unit reference mounting surface is always the side surface opposite to the  mark. The track rail reference mounting surface is identified by locating the  mark on the top surface of the track rail. The track rail reference mounting surface is the side surface above the  mark (in the direction of the arrow). (See Fig. 5.)

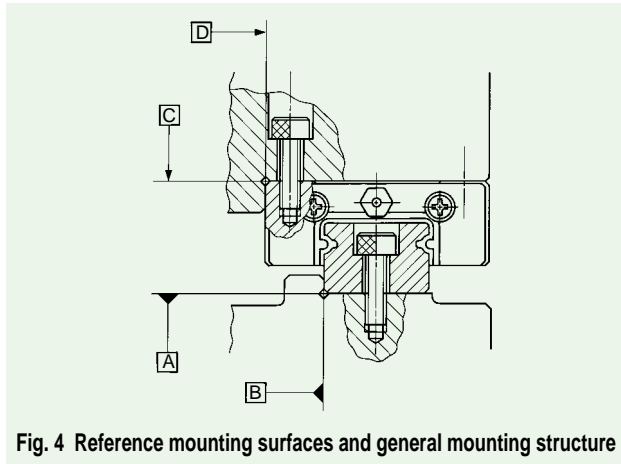

Fig. 4 Reference mounting surfaces and general mounting structure

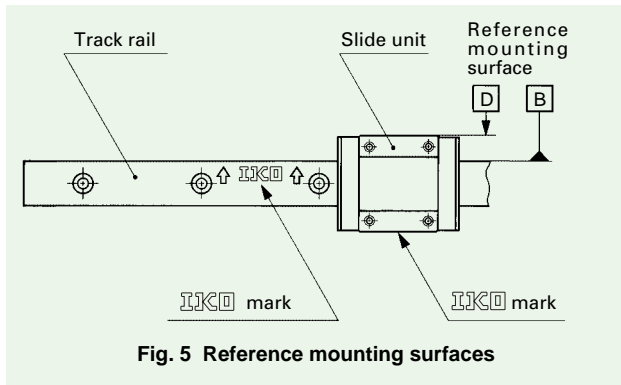

Fig. 5 Reference mounting surfaces

2 Mounting bolts of the slide unit

For the size 2, 3, 4, and 6 models, the female threads for mounting the slide unit are through thread holes. If the fixing depth of the mounting bolts is too long, the bolts will interfere with the track rail, resulting in poor traveling accuracy and short life. The fixing depth of the mounting bolts should be kept within the values shown in the table of dimensions.

3 Mounting bolts of the track rail

For the tapped rail specification models, mounting bolts for track rail are not attached. Prepare bolts with a fixing depth not exceeding the length H4 in the table of dimensions.

4 Corner radius and shoulder height of reference mounting surfaces

It is recommended to make a relieved fillet at the corner of the mating reference mounting surfaces as shown in Fig. 4. Table 14 shows recommended shoulder heights of the mating reference mounting surfaces.

Table 14 Shoulder heights of the mating reference mounting surfaces

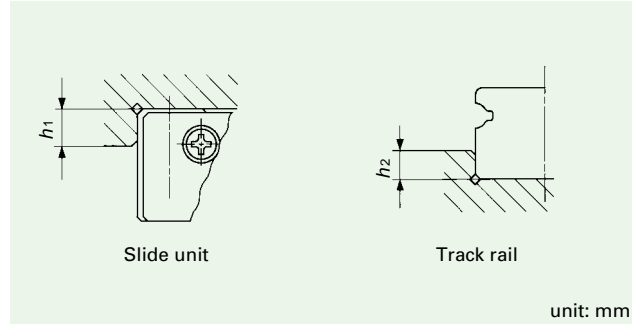

| unit: mm | | | |
|--------------|-------------|----------------------------------|---|
| Model number | | Slide unit shoulder height h_1 | Track rail ⁽¹⁾ shoulder height h_2 |
| LWL 2 | — | 1 | 0.5 |
| LWL 3 | LWLF 4 | 1.2 | 0.8 |
| — | LWLF 6 | 1.5 | 0.8 |
| LWL 5...B | — | 2 | 0.8 |
| — | LWLF 10...B | 2 | 1.2 |
| LWL 7...B | LWLF 14...B | 2.5 | 1.2 |
| LWL 9...B | — | 3 | 1.5 |
| — | LWLF 18...B | 3 | 2.5 |
| LWL 12...B | LWLF 24...B | 4 | 2.5 |
| — | LWLF 30...B | 4.5 | 2.5 |
| LWL 15...B | — | 4.5 | 3 |
| — | LWLF 42...B | 5 | 3 |
| LWL 20...B | — | 5 | 4 |
| LWL 25...B | — | 6.5 | 4 |

Note(1): For "with under seals" (supplemental code "/U"), it is recommended to use a value obtained by subtracting 1 mm from the value shown in the table. However, for "with under seals" of the size 9 models, 0.8 mm is recommended.

Remark: The above table shows representative model numbers but is applicable to all models of the same size.

5 Multiple slide units mounted in close distance

When using multiple slide units in close distance to each other, actual load may be greater than the calculated load depending on the mounting accuracy of the slide units on the mounting surfaces and the reference mounting surfaces of the machine. It is suggested in such cases to assume a greater load than the calculated load.

6 Operating temperature

The maximum operating temperature is 120°C and a continuous operation is possible at temperatures up to 100°C. When the temperature exceeds 100°C, consult . For the "with capillary plate" (supplemental code "/Q") of special specification, operate Linear Way L below 80°C.

Mounting

① When mounting multiple sets at the same time

In the case of interchangeable specification Linear Way L, assemble a slide unit and a track rail with the same interchangeable code ("S1" or "S2").

In the case of non-interchangeable specification Linear Way L, use an assembly of slide unit and track rail as delivered without changing the combination.

In the case of matched sets to be used as an assembled group, special specification products of matched sets (supplemental code "/W") are delivered as a group in which dimensional variations are specially controlled. Mount them without mixing with the sets of another group.

② Assembling a slide unit and a track unit

When assembling Linear Way L, correctly fit the grooves of the slide unit mounted on a dummy rail (steel ball holder) to the grooves of the track rail, and then move the slide unit gently in parallel direction.

Steel balls are retained in Linear Way L Ball Retained type (except sizes 2, 3, 4, and 6), so the slide unit can be separated freely from the track rail. However, the slide unit can be assembled on the track rail much easier by using the dummy rail (steel ball holder).

In Linear Way L Non-Ball Retained type (sizes 2, 3, 4, and 6), steel balls are not retained. When separating the slide unit from the track rail, a dummy rail (steel ball holder) should be used.

The slide unit of Linear Way L of interchangeable specification is already assembled on a dummy rail (steel ball holder). The steel ball holder is appended as an accessory to models shown in Table 15. The steel ball holders for other models are also available. If required, consult  for further information.

Table 15 Models to which a steel ball holder is appended

| Standard type | Wide rail type |
|---------------------------------------|---|
| LWL 2 | LWLF 4 |
| LWLC 3 LWL 3 | LWLFC 6 LWLF 6 |
| LWLC 5...B LWL 5...B | LWLFC 10...B LWLF 10...B |
| LWLC 7...B LWL 7...B LWLG 7...B | LWLFC 14...B LWLF 14...B LWLFG 14...B |
| LWLC 9...B LWL 9...B LWLG 9...B | LWLFC 18...B LWLF 18...B LWLFG 18...B |
| LWLG 12...B | LWLFG 24...B |
| LWLG 15...B | LWLFG 30...B |
| LWLG 20...B | LWLFG 42...B |
| LWLG 25...B | — |

Remark: The above table shows representative model numbers but is applicable to all models of the same size.

③ Cleaning of mounting surfaces

When mounting Linear Way L, remove burrs and blemishes from the mounting surfaces and reference mounting surfaces of machines and equipment and wipe off the rust preventive oil and foreign substances with clean cloth.

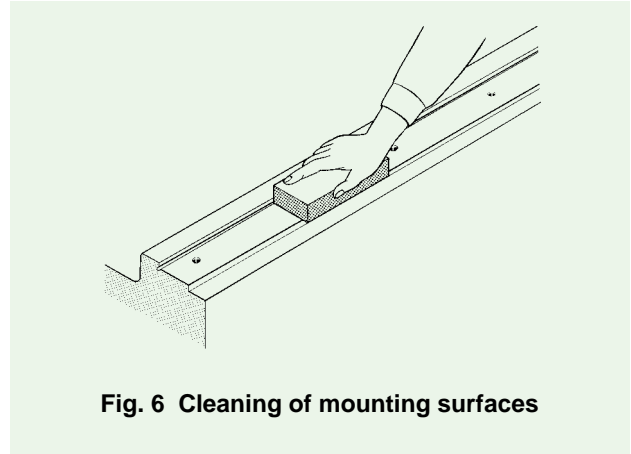

Fig. 6 Cleaning of mounting surfaces

④ Tightening torque of mounting bolts

The standard torque values for mounting Linear Way L on the mating steel made member are shown in Table 16. When machines or equipment are subjected to severe vibration, shock, large fluctuating load, or moment load, the bolts should be tightened with a torque 1.2 to 1.5 times higher than the standard torque values shown. When the mating member material is cast iron or aluminum, tightening torque should be lowered in accordance with the strength characteristics of the material.

Table 16 Tightening torque of mounting bolts

| Bolt size | Tightening torque N·m | |
|-------------|---|---|
| | Stainless steel bolt (Property division A2-70) | Carbon steel bolt (Strength division 12.9) |
| M1 × 0.25 | 0.04 | — |
| M1.4 × 0.3 | 0.1 | — |
| M1.6 × 0.35 | 0.15 | — |
| M2 × 0.4 | 0.31 | — |
| M2.5 × 0.45 | 0.62 | — |
| M3 × 0.5 | 1.1 | 1.2 |
| M4 × 0.7 | 2.5 | 2.8 |
| M5 × 0.8 | 5.0 | 5.6 |
| M6 × 1.0 | 8.5 | — |

Track Rail Length

Standard and maximum lengths of track rails are shown in Table 17. Track rails in any length are also available. Simply indicate the necessary length of track rail in mm in the identification number.

For stainless steel non-interchangeable track rails longer than the maximum length shown in Table 17.1, butt-jointing track rails are available upon request. In this case, indicate "/A" in

the identification number.

E dimensions at both ends are the same unless otherwise specified. To change these dimensions, specify the specified rail mounting hole positions (supplemental code "/E") of special specification.

Table 17.1 Standard and maximum lengths of stainless steel track rails

unit: mm

| Model number | LWL 2 | LWL 3 | LWL 5...B LWL 5...N | LWL 7...B LWL 7...N | LWL 9...B LWL 9...N | LWL 12...B | LWL 15...B | LWL 20...B | LWL 25...B |
|---|---|---|--|---|---|--|--|--|--|
| Standard length $L(n)$ | 32(4) 40(5) 56(7) 80(10) | 30(3) 40(4) 60(6) 80(8) 100(10) | 60(4) 90(6) 105(7) 120(8) 150(10) 150(10) | 60(4) 90(6) 120(8) 150(10) 180(12) 240(16) | 60(3) 80(4) 120(6) 160(8) 220(11) 280(14) | 100(4) 150(6) 200(8) 275(11) 350(14) 475(19) | 160(4) 240(6) 320(8) 440(11) 560(14) 680(17) | 180(3) 240(4) 360(6) 480(8) 660(11) 840(14) | 240(4) 300(5) 360(6) 480(8) 660(11) 900(15) |
| Pitch of mounting holes F | 8 | 10 | 15 | 15 | 20 | 25 | 40 | 60 | 60 |
| E | 4 | 5 | 7.5 | 7.5 | 10 | 12.5 | 20 | 30 | 30 |
| Maximum length ⁽¹⁾ | 104 | 150 (200) | 210 (300) | 300 (390) | 860 (960) | 1 000 (1 200) | 1 000 (1 200) | 960 (1 200) | 960 (1 200) |
| Maximum number of butt-jointing track rails | — | — | 5 | 7 | 2 | 2 | 2 | 2 | 2 |
| Maximum length of butt-jointing track rails | — | — | 915 | 1 905 | 1 660 | 1 925 | 1 880 | 1 740 | 1 740 |
| Model number | LWLF 4 | LWLF 6 LWLF 6...N | LWLF 10...B LWLF 10...N | LWLF 14...B LWLF 14...N | LWLF 18...B LWLF 18...N | LWLF 24...B | LWLF 30...B | LWLF 42...B | |
| Standard length $L(n)$ | 40(4) 60(6) 70(7) 80(8) 100(10) | 60(4) 90(6) 105(7) 120(8) 150(10) | 60(3) 80(4) 120(6) 160(8) 220(11) 280(14) | 90(3) 120(4) 150(5) 180(6) 240(8) 300(10) | 90(3) 120(4) 150(5) 180(6) 240(8) 300(10) | 120(3) 160(4) 240(6) 320(8) 400(10) 480(12) | 160(4) 240(6) 320(8) 440(11) 560(14) 680(17) | 160(4) 240(6) 320(8) 440(11) 560(14) 680(17) | |
| Pitch of mounting holes F | 10 | 15 | 20 | 30 | 30 | 40 | 40 | 40 | |
| E | 5 | 7.5 | 10 | 15 | 15 | 20 | 20 | 20 | |
| Maximum length ⁽¹⁾ | 180 | 240 (300) | 300 (400) | 300 (600) | 690 (960) | 680 (1 000) | 680 (1 000) | 680 (1 000) | |
| Maximum number of butt-jointing track rails | — | — | 7 | 8 | 3 | 3 | 3 | 3 | |
| Maximum length of butt-jointing track rails | — | — | 1 840 | 1 950 | 1 920 | 1 840 | 1 840 | 1 840 | |

Note(1): The track rails can be manufactured up to the maximum lengths shown in parentheses. If required, consult for further information.

Remarks 1. The above table shows representative model numbers but is applicable to all stainless steel track rails of the same size.

- " Butt-jointing track rails" (supplemental code "/A") specification applies to the track rails of non-interchangeable specification but does not apply to those of tapped rail specification.

Table 17.2 Standard and maximum lengths of high carbon steel track rails

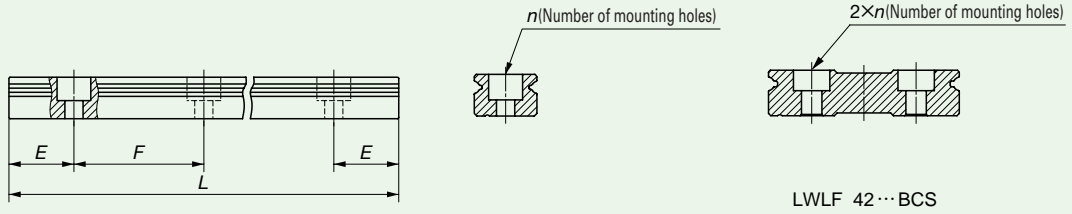

unit: mm

| Model number | | LWL 9...BCS | LWL 12...BCS | LWL 15...BCS | LWL 20...BCS |
|-----------------------------|--|--|---|---|--|
| Item | | | | | |
| Standard length $L(n)$ | | 80(4) 160(8) 220(11) 280(14) 380(19) 500(25) 600(30) | 100(4) 200(8) 275(11) 350(14) 475(19) 600(24) 700(28) | 160(4) 320(8) 440(11) 560(14) 680(17) 800(20) 920(23) | 180(3) 240(4) 360(6) 480(8) 660(11) 900(15) 1020(17) |
| Pitch of mounting holes F | | 20 | 25 | 40 | 60 |
| E | | 10 | 12.5 | 20 | 30 |
| Maximum length | | 1 000 | 1 500 | 1 520 | 1 560 |
| Model number | | LWLF 18...BCS | LWLF 24...BCS | LWLF 30...BCS | LWLF 42...BCS |
| Item | | | | | |
| Standard length $L(n)$ | | 90(3) 180(6) 240(8) 300(10) 420(14) 510(17) 600(20) | 120(3) 240(6) 320(8) 400(10) 600(15) 720(18) 800(20) | 160(4) 320(8) 440(11) 560(14) 680(17) 800(20) 920(23) | 160(4) 320(8) 440(11) 560(14) 680(17) 800(20) 920(23) |
| Pitch of mounting holes F | | 30 | 40 | 40 | 40 |
| E | | 15 | 20 | 20 | 20 |
| Maximum length | | 1 500 | 1 520 | 1 600 | 1 600 |

IKO Linear Way L: Standard type

LWLC, LWL, LWLG

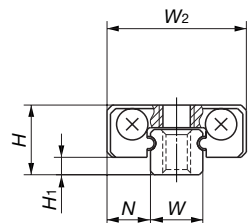

LWL 2
LWLC 3
LWL 3

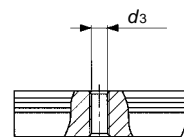
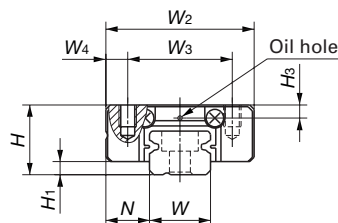

Tapped rail specification
LWL 2
LWLC 3
LWL 3
LWL...N

| Model number | Interchangeable | Mass (Ref.) g | | Dimensions of assembly mm | | | Dimensions of slide unit mm | | | | | | | | |
|--------------|-----------------|------------------|----------------------------|---------------------------------|----------------|-----|-----------------------------|----------------|----------------|----------------|----------------|----------------|------------------------|----------------|---|
| | | Slide unit | Track rail (per 100 mm) | H | H ₁ | N | W ₂ | W ₃ | W ₄ | L ₁ | L ₂ | L ₃ | M ₁ × depth | H ₃ | W |
| LWL 2(1) | | 0.9 | 2.8 | 3.2 | 0.7 | 2 | 6 | — | — | 12.4 | 4 | 8.8 | M1.4 × 1.1 | — | 2 |
| LWLC 3(1) | | 1.0 | 5.3 | 4 | 1 | 2.5 | 8 | — | — | 12 | 3.5 | 6.7 | M1.6 × 1.3 | — | 3 |
| LWL 3(1) | | 1.6 | | | | | | | | 16 | 5.5 | 10.7 | | | |
| LWLC 5...B | ☆ | 3.4 | 12 | 6 | 1 | 3.5 | 12 | 8 | 2 | 16 | — | 9.6 | M2 × 1.5 | 1.2 | 5 |
| LWLC 5...N | | | 13 | | | | | | | | | | | | |
| LWL 5...B | ☆ | 4.4 | 12 | 6 | 1 | 3.5 | 12 | 8 | 2 | 19 | — | 12.6 | M2 × 1.5 | 1.2 | 5 |
| LWL 5...N | | | 13 | | | | | | | | | | | | |
| LWLC 7...B | ☆ | 7.1 | 22 | 8 | 1.5 | 5 | 17 | 12 | 2.5 | 19 | — | 9.6 | M2 × 2.5 | 1.5 | 7 |
| LWLC 7...N | | | 24 | | | | | | | | | | | | |
| LWL 7...B | ☆ | 10 | 22 | 8 | 1.5 | 5 | 17 | 12 | 2.5 | 23.5 | 8 | 14.3 | M2 × 2.5 | 1.5 | 7 |
| LWL 7...N | | | 24 | | | | | | | | | | | | |
| LWLG 7...B | ☆ | 14 | 22 | 8 | 1.5 | 5 | 17 | 12 | 2.5 | 31 | 12 | 21.6 | M2 × 2.5 | 1.5 | 7 |
| LWLG 7...N | | | 24 | | | | | | | | | | | | |
| LWLC 9...B | ☆ | 11 | 35 | 10 | 2 | 5.5 | 20 | 15 | 2.5 | 21.5 | — | 11.9 | M3 × 3 | 2.2 | 9 |
| LWLC 9...N | | | 37 | | | | | | | | | | | | |
| LWL 9...B | ☆ | 19 | 35 | 10 | 2 | 5.5 | 20 | 15 | 2.5 | 30 | 10 | 20.8 | M3 × 3 | 2.2 | 9 |
| LWL 9...N | | | 37 | | | | | | | | | | | | |
| LWL 9...BCS | ☆ | 28 | 35 | 10 | 2 | 5.5 | 20 | 15 | 2.5 | 40.5 | 15 | 30.9 | M3 × 3 | 2.2 | 9 |
| LWLG 9...B | ☆ | | 37 | | | | | | | | | | | | |
| LWLG 9...N | | 28 | 37 | 10 | 2 | 5.5 | 20 | 15 | 2.5 | 40.5 | 15 | 30.9 | M3 × 3 | 2.2 | 9 |

Note(1): Steel balls are not retained in LWL 2, LWLC 3, and LWL 3. These models are not provided with end seals and an oil hole.

(2): Prepare track rail mounting bolts with a proper bolt length l such that the fixing depth becomes less than H_4 .

(3): Track rail lengths L are shown in Table 17.

(4): The directions of basic dynamic load rating (C), basic static load rating (C_0), and static moment rating (T_0 , T_x , and T_y) are shown in the sketches below.

The upper values in the T_x and T_y columns apply to one slide unit, and the lower values apply to two slide units in close contact.

Remarks 1. The mark ☆ indicates that interchangeable specification products are available.

2. The appended bolts for mounting track rails are hexagon socket head bolts of JIS B 1176 or equivalent, or cross recessed head screws for precision equipment. For stainless steel series Linear Way L, stainless steel bolts or screws are appended.

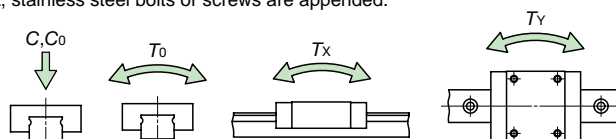

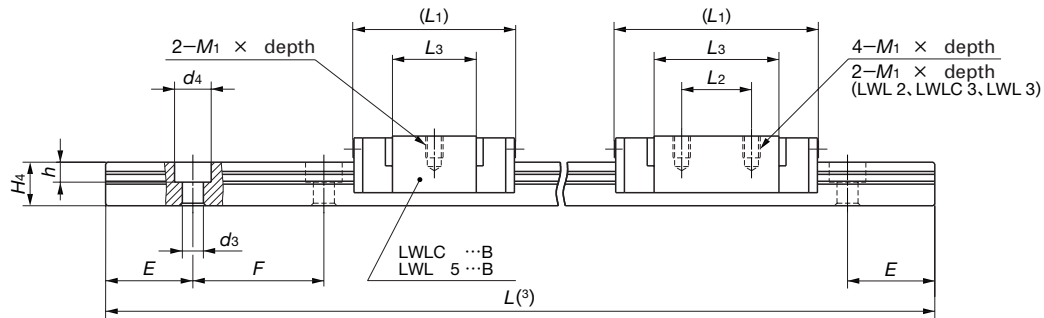

| Dimensions of track rail mm | | | | | | Appended mounting bolt for track rail mm Bolt size × ℓ | Basic dynamic load rating ⁽⁴⁾ C N | Basic static load rating ⁽⁴⁾ C ₀ N | Static moment rating ⁽⁴⁾ | | | Model number |
|-----------------------------|----------------|----------------|-------------------------------|-----|----|---|--|--|-------------------------------------|-----------------------|-----------------------|-----------------------|
| H ₄ | d ₃ | d ₄ | h | E | F | | | | T ₀ N-m | T _X N-m | T _Y N-m | |
| 2 | M1 Through | — | — | 4 | 8 | (not appended) ⁽²⁾ | 204 | 395 | 0.43 | 0.56 3.0 | 0.67 3.6 | LWL 2 ⁽¹⁾ |
| 2.6 | M1.6 Through | — | — | 5 | 10 | (not appended) ⁽²⁾ | 245 | 375 | 0.60 | 0.41 3.0 | 0.49 3.5 | LWLC 3 ⁽¹⁾ |
| | | | | | | | 339 | 609 | 0.97 | 1.0 6.1 | 1.2 7.2 | LWL 3 ⁽¹⁾ |
| 3.7 | 2.4 | 3.6 | 0.8 | 7.5 | 15 | Cross recessed head screw for precision equipment M2 × 6 | 514 | 872 | 2.3 | 1.4 8.9 | 1.2 7.4 | LWLC 5 ... B |
| | M2.5 Through | — | (not appended) ⁽²⁾ | | | LWLC 5 ... N | | | | | | |
| | 2.4 | 3.6 | 0.8 | | | Cross recessed head screw for precision equipment M2 × 6 | 612 | 1 130 | 3.0 | 2.4 13.3 | 2.0 11.2 | LWL 5 ... B |
| | M2.5 Through | — | (not appended) ⁽²⁾ | | | LWL 5 ... N | | | | | | |
| 5 | 2.4 | 4.2 | 2.3 | 7.5 | 15 | Hexagon socket head bolt M2 × 6 | 856 | 1 180 | 4.3 | 1.9 15.4 | 1.6 12.9 | LWLC 7 ... B |
| | M3 Through | — | (not appended) ⁽²⁾ | | | LWLC 7 ... N | | | | | | |
| | 2.4 | 4.2 | 2.3 | | | Hexagon socket head bolt M2 × 6 | 1 200 | 1 960 | 7.2 | 4.9 29.2 | 4.1 24.5 | LWL 7 ... B |
| | M3 Through | — | (not appended) ⁽²⁾ | | | LWL 7 ... N | | | | | | |
| | 2.4 | 4.2 | 2.3 | | | Hexagon socket head bolt M2 × 6 | 1 510 | 2 750 | 10.0 | 9.1 52.6 | 7.7 44.1 | LWLG 7 ... B |
| | M3 Through | — | (not appended) ⁽²⁾ | | | LWLG 7 ... N | | | | | | |
| 6 | 3.5 | 6 | 3.5 | 10 | 20 | Hexagon socket head bolt M3 × 8 | 1 070 | 1 540 | 7.2 | 3.0 22.2 | 2.5 18.6 | LWLC 9 ... B |
| | M4 Through | — | (not appended) ⁽²⁾ | | | LWLC 9 ... N | | | | | | |
| | 3.5 | 6 | 3.5 | | | Hexagon socket head bolt M3 × 8 | 1 610 | 2 860 | 13.3 | 9.4 53.0 | 7.9 44.5 | LWL 9 ... B |
| | M4 Through | — | (not appended) ⁽²⁾ | | | LWL 9 ... N | | | | | | |
| | 3.5 | 6 | 3.5 | | | Hexagon socket head bolt M3 × 8 | 2 080 | 4 180 | 19.4 | 19.4 102 | 16.3 85.6 | LWL 9 ... BCS |
| | M4 Through | — | (not appended) ⁽²⁾ | | | LWLG 9 ... B | | | | | | |
| | | | | | | | | | | | | LWLG 9 ... N |

Example of identification number of assembled set

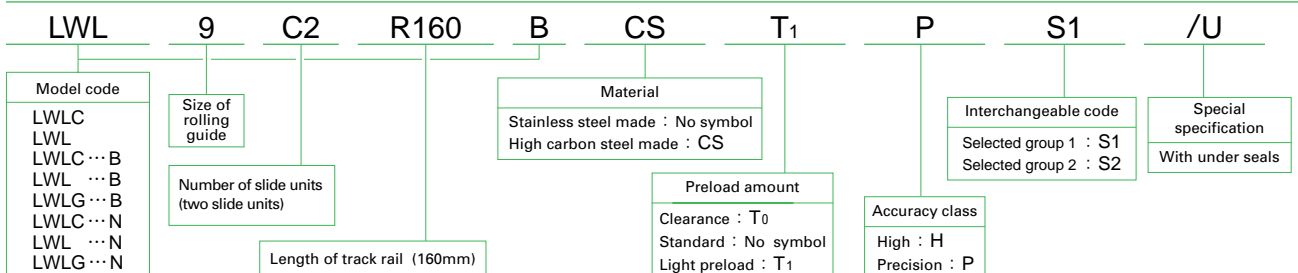

1N=0.102kgf=0.2248lbs.
1mm=0.03937inch

IKO Linear Way L: Standard type

LWLC, LWL, LWLG

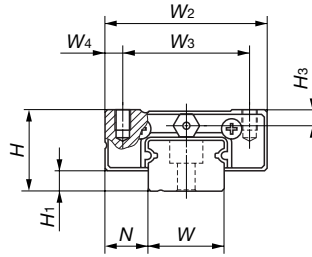

| Model number | Interchangeable | Mass (Ref.) g | | Dimensions of assembly mm | | | Dimensions of slide unit mm | | | | | | | | | |
|--------------|-----------------|------------------|----------------------------|---------------------------------|----------------|------|-----------------------------|----------------|----------------|----------------|----------------|----------------|----------------|------------------------|----------------|----|
| | | Slide unit | Track rail (per 100 mm) | H | H ₁ | N | W ₂ | W ₃ | W ₄ | L ₁ | L ₂ | L ₃ | L ₄ | M ₁ × depth | H ₃ | W |
| LWLC 12...B | ☆ | 22 | 65 | 13 | 3 | 7.5 | 27 | 20 | 3.5 | 25 | — | 13 | — | M3 × 3.5 | 2.7 | 12 |
| LWL 12...B | ☆ | 35 | | | | | | | | 34 | 15 | 21.6 | | | | |
| LWL 12...BCS | ☆ | 51 | | | | | | | | 44 | 20 | 32 | | | | |
| LWLG 12...B | ☆ | 42 | | | | | | | | 32 | — | 17.7 | | | | |
| LWLC 15...B | ☆ | 42 | 107 | 16 | 4 | 8.5 | 32 | 25 | 3.5 | 42 | 20 | 27.8 | 47 | M3 × 4 | 3.1 | 15 |
| LWL 15...B | ☆ | 64 | | | | | | | | 42 | 20 | 27.8 | 47 | | | |
| LWL 15...BCS | ☆ | 95 | | | | | | | | 57 | 25 | 42.7 | 62 | | | |
| LWLG 15...B | ☆ | 89 | | | | | | | | 38 | — | 22.3 | 42 | | | |
| LWLC 20...B | ☆ | 89 | 156 | 20 | 5 | 10 | 40 | 30 | 5 | 50 | 25 | 34.6 | 55 | M4 × 6 | 4.2 | 20 |
| LWL 20...B | ☆ | 133 | | | | | | | | 50 | 25 | 34.6 | 55 | | | |
| LWL 20...BCS | ☆ | 196 | | | | | | | | 68 | 30 | 52.3 | 72 | | | |
| LWLG 20...B | ☆ | 190 | | | | | | | | 55 | — | 31.9 | 65 | | | |
| LWLC 25...B | ☆ | 190 | 243 | 25 | 5 | 12.5 | 48 | 35 | 6.5 | 78 | 35 | 55.7 | 89 | M6 × 7 | 5 | 23 |
| LWL 25...B | ☆ | 310 | | | | | | | | 78 | 35 | 55.7 | 89 | | | |
| LWLC 25...B | ☆ | 413 | | | | | | | | 98 | 40 | 75.5 | 108 | | | |
| LWLG 25...B | ☆ | 413 | | | | | | | | 98 | 40 | 75.5 | 108 | | | |

Note(1): Track rail lengths *L* are shown in Table 17.

(2): The directions of basic dynamic load rating (*C*), basic static load rating (*C₀*), and static moment rating (*T₀*, *T_x*, and *T_y*) are shown in the sketches below.

The upper values in the *T_x* and *T_y* columns apply to one slide unit, and the lower values apply to two slide units in close contact.

Remarks 1. The mark ☆ indicates that interchangeable specification products are available.

2. The appended bolts for mounting track rails are hexagon socket head bolts of JIS B 1176 or equivalent, or cross recessed head screws for precision equipment. For stainless steel series Linear Way L, stainless steel bolts or screws are appended.

3. An oil hole is provided for LWLC 12...B, LWL 12...B, LWL 12...BCS, and LWLG 12...B.

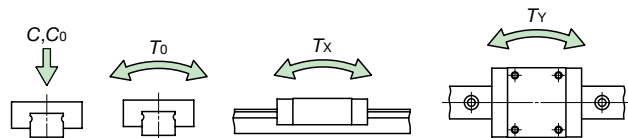

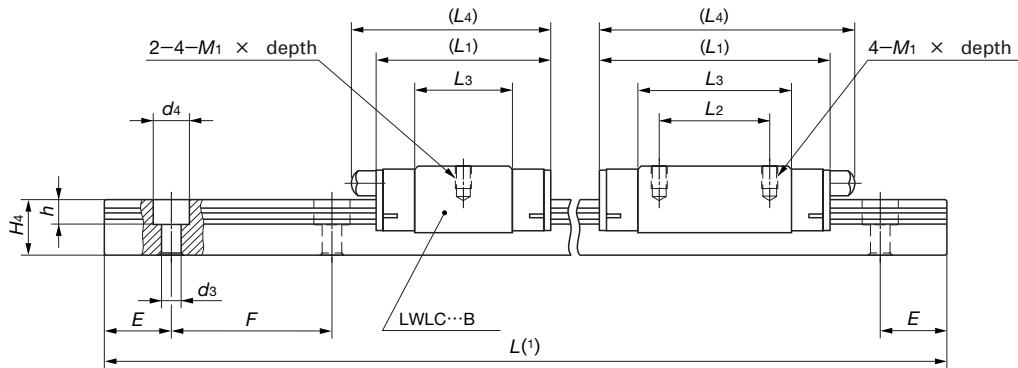

| Dimensions of track rail mm | | | | | | Appended mounting bolt for track rail mm Bolt size \times ℓ | Basic dynamic load rating ⁽²⁾ C N | Basic static load rating ⁽²⁾ C ₀ N | Static moment rating ⁽²⁾ | | | Model number |
|-----------------------------|-------|-------|-----|------|-----|---|--|--|-------------------------------------|--------------|--------------|--|
| H_4 | d_3 | d_4 | h | E | F | | | | T_0 N-m | T_x N-m | T_y N-m | |
| 8 | 3.5 | 6.5 | 4.5 | 12.5 | 25 | M3 \times 8 | 2 000 | 2 470 | 15.3 | 5.5 43.3 | 4.7 36.3 | LWLC 12...B LWL 12...B LWL 12...BCS LWLG 12...B |
| | | | | | | | 2 960 | 4 450 | 27.6 | 16.0 96.6 | 13.4 81.1 | |
| | | | | | | | 3 780 | 6 430 | 39.9 | 31.8 174 | 26.7 146 | |
| | | | | | | | 3 120 | 4 040 | 31.1 | 12.1 87.6 | 10.2 73.5 | |
| 10 | 3.5 | 6.5 | 4.5 | 20 | 40 | M3 \times 10 | 4 390 | 6 730 | 51.8 | 30.8 178 | 25.9 149 | LWLC 15...B LWL 15...B LWL 15...BCS LWLG 15...B |
| | | | | | | | 5 750 | 10 100 | 77.7 | 66.2 351 | 55.6 294 | |
| | | | | | | | 4 070 | 5 490 | 56.0 | 20.2 138 | 16.9 116 | |
| 11 | 6 | 9.5 | 5.5 | 30 | 60 | M5 \times 14 | 5 830 | 9 420 | 96.1 | 54.6 291 | 45.8 244 | LWLC 20...B LWL 20...B LWL 20...BCS LWLG 20...B |
| | | | | | | | 7 350 | 13 300 | 136 | 106 549 | 88.9 461 | |
| | | | | | | | 8 000 | 11 000 | 132 | 59.5 387 | 49.9 324 | |
| 15 | 7 | 11.0 | 9.0 | 30 | 60 | M6 \times 16 | 11 600 | 19 200 | 232 | 169 919 | 142 771 | LWLC 25...B LWL 25...B LWLG 25...B |
| | | | | | | | 14 200 | 26 100 | 315 | 304 1 530 | 255 1 290 | |
| | | | | | | | | | | | | |

Example of identification number of assembled set

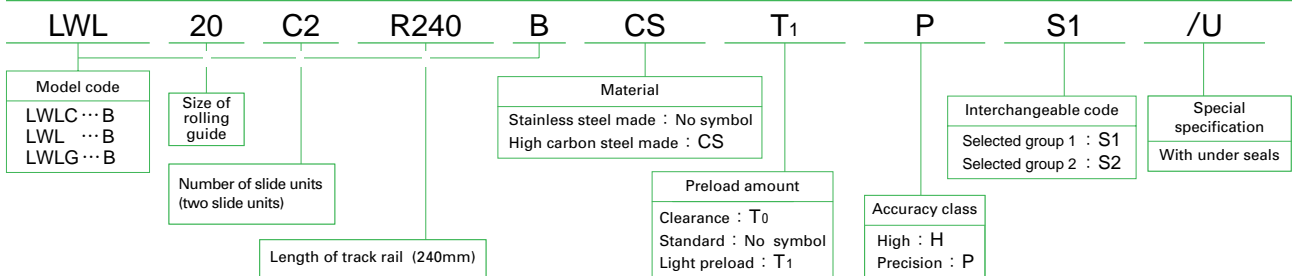

IKO Linear Way L: Wide rail type

LWLFC, LWLF, LWLFG

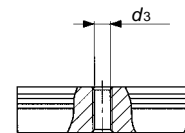
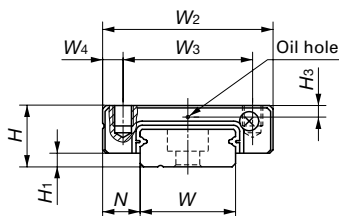

Tapped rail specification
LWLF...N

| Model number | Interchangeable | Mass (Ref.) g | | Dimensions of assembly mm | | | Dimensions of slide unit mm | | | | | | | | |
|----------------------------|-----------------|------------------|----------------------------|---------------------------------|----------------|-----|-----------------------------|----------------|----------------|----------------|----------------|----------------|------------------------|----------------|----|
| | | Slide unit | Track rail (per 100 mm) | H | H ₁ | N | W ₂ | W ₃ | W ₄ | L ₁ | L ₂ | L ₃ | M ₁ × depth | H ₃ | W |
| LWLF 4 ⁽¹⁾ | | 2.1 | 6.8 | 4 | 1 | 3 | 10 | — | 5 | 17 | 6.5 | 11.9 | M2 × 1.3 | — | 4 |
| LWLFC 6 ⁽¹⁾ | | 2.4 | 13 | 4.5 | 1 | 3 | 12 | — | 6 | 15 | 4.5 | 9.8 | M2 × 1.6 | — | 6 |
| LWLFC 6...N ⁽¹⁾ | 12 | | | | | | | | | | | | | | |
| LWLF 6 ⁽¹⁾ | | 3.4 | 13 | 4.5 | 1 | 3 | 12 | — | 6 | 20 | 8 | 14.6 | M2 × 1.6 | — | 6 |
| LWLF 6...N ⁽¹⁾ | 12 | | | | | | | | | | | | | | |
| LWLFC 10...B | ☆ | 5.9 | 28 | 6.5 | 1.5 | 3.5 | 17 | 13 | 2 | 20.5 | — | 13.6 | M2.5 × 1.5 | 1.3 | 10 |
| LWLFC 10...N | | | 29 | | | | | | | 17.6 | | | | | |
| LWLF 10...B | ☆ | 7.5 | 28 | 6.5 | 1.5 | 3.5 | 17 | 13 | 2 | 24.5 | — | 17.6 | M2.5 × 1.5 | 1.3 | 10 |
| LWLF 10...N | | | 29 | | | | | | | | | | | | |
| LWLFC 14...B | ☆ | 13 | 54 | 9 | 2 | 5.5 | 25 | 19 | 3 | 22.5 | — | 13 | M3 × 3 | 1.7 | 14 |
| LWLFC 14...N | | | 56 | | | | | | | | | | | | |
| LWLF 14...B | ☆ | 21 | 54 | 9 | 2 | 5.5 | 25 | 19 | 3 | 31.5 | 10 | 22 | M3 × 3 | 1.7 | 14 |
| LWLF 14...N | | | 56 | | | | | | | | | | | | |
| LWLFG 14...B | ☆ | 31 | 54 | 9 | 2 | 5.5 | 25 | 19 | 3 | 42 | 19 | 32.5 | M3 × 3 | 1.7 | 14 |
| LWLFG 14...N | | | 56 | | | | | | | | | | | | |
| LWLFC 18...B | ☆ | 26 | 90 | 12 | 3 | 6 | 30 | 21 | 4.5 | 26.5 | — | 16.6 | M3 × 3 | 2.5 | 18 |
| LWLFC 18...N | | | 92 | | | | | | | | | | | | |
| LWLF 18...B | ☆ | 44 | 90 | 12 | 3 | 6 | 30 | 21 | 4.5 | 39 | 12 | 28.6 | M3 × 3 | 2.5 | 18 |
| LWLF 18...N | | | 92 | | | | | | | | | | | | |
| LWLF 18...BCS | ☆ | 44 | 90 | 12 | 3 | 6 | 30 | 21 | 4.5 | 39 | 12 | 28.6 | M3 × 3 | 2.5 | 18 |
| LWLFG 18...B | ☆ | | 90 | | | | | | | | | | | | |
| LWLFG 18...N | | 44 | 92 | 12 | 3 | 6 | 30 | 21 | 4.5 | 50.5 | 24 | 40.4 | M3 × 3 | 2.5 | 18 |

Note⁽¹⁾: Steel balls are not retained in LWLF 4, LWLFC 6, LWLFC 6...N, LWLF 6, and LWLF 6...N. These models are not provided with end seals and an oil hole.

⁽²⁾: Prepare track rail mounting bolts with a proper bolt length l such that the fixing depth becomes less than H_4 .

⁽³⁾: Track rail lengths L are shown in Table 17.

⁽⁴⁾: The directions of basic dynamic load rating (C), basic static load rating (C_0), and static moment rating (T_0 , T_x , and T_y) are shown in the sketches below.

The upper values in the T_x and T_y columns apply to one slide unit, and the lower values apply to two slide units in close contact.

Remarks 1. The mark ☆ indicates that interchangeable specification products are available.

2. The appended bolts for mounting track rails are hexagon socket head bolts of JIS B 1176 or equivalent, or cross recessed head screws for precision equipment. For stainless steel series Linear Way L, stainless steel bolts or screws are appended.

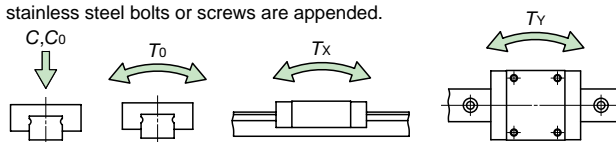

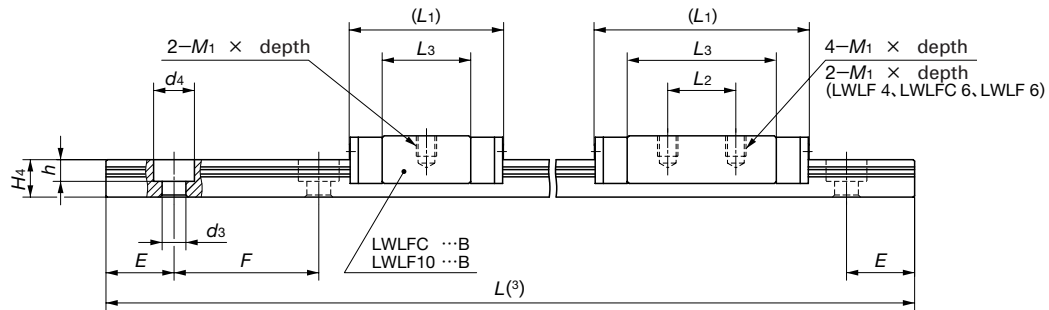

| Dimensions of track rail mm | | | | | | Appended mounting bolt for track rail mm Bolt size × ℓ | Basic dynamic load rating ⁽⁴⁾ C N | Basic static load rating ⁽⁴⁾ C ₀ N | Static moment rating ⁽⁴⁾ | | | Model number |
|-----------------------------|----------------|----------------|-------------------------------|-----|----|--|--|--|-------------------------------------|-----------------------|-----------------------|-----------------------------|
| H ₄ | d ₃ | d ₄ | h | E | F | | | | T ₀ N-m | T _X N-m | T _Y N-m | |
| 2.6 | 1.8 | 2.8 | 0.75 | 5.0 | 10 | Cross recessed head screw for precision equipment M1.6 × 5 | 373 | 703 | 1.5 | 1.3 7.3 | 1.6 8.7 | LWLF 4⁽¹⁾ |
| 2.8 | 2.4 | 4 | 1.5 | 7.5 | 15 | Cross recessed head screw for precision equipment M2 × 4 | 321 | 562 | 1.7 | 0.87 5.3 | 1.0 6.3 | LWLF 6⁽¹⁾ |
| | M 3 Through | — | (not appended) ⁽²⁾ | | | LWLF 6...N⁽¹⁾ | | | | | | |
| | 2.4 | 4 | 1.5 | | | Cross recessed head screw for precision equipment M2 × 4 | 421 | 843 | 2.6 | 1.9 10.2 | 2.2 12.2 | LWLF 6⁽¹⁾ |
| | M 3 Through | — | (not appended) ⁽²⁾ | | | LWLF 6...N⁽¹⁾ | | | | | | |
| 4 | 2.9 | 4.8 | 1.6 | 10 | 20 | Cross recessed head screw for precision equipment M2.5 × 7 | 643 | 1 220 | 6.3 | 2.7 15.4 | 2.3 13.0 | LWLF 10...B |
| | M 3 Through | — | (not appended) ⁽²⁾ | | | LWLF 10...N | | | | | | |
| | 2.9 | 4.8 | 1.6 | | | Cross recessed head screw for precision equipment M2.5 × 7 | 760 | 1 570 | 8.1 | 4.4 23.3 | 3.7 19.5 | LWLF 10...B |
| | M 3 Through | — | (not appended) ⁽²⁾ | | | LWLF 10...N | | | | | | |
| 5.5 | 3.5 | 6 | 3.2 | 15 | 30 | Hexagon socket head bolt M3 × 8 | 1 120 | 1 770 | 12.6 | 4.0 25.6 | 3.3 21.4 | LWLF 14...B |
| | M 4 Through | — | (not appended) ⁽²⁾ | | | LWLF 14...N | | | | | | |
| | 3.5 | 6 | 3.2 | | | Hexagon socket head bolt M3 × 8 | 1 580 | 2 940 | 21.0 | 10.4 56.7 | 8.7 47.6 | LWLF 14...B |
| | M 4 Through | — | (not appended) ⁽²⁾ | | | LWLF 14...N | | | | | | |
| | 3.5 | 6 | 3.2 | | | Hexagon socket head bolt M3 × 8 | 2 040 | 4 320 | 30.9 | 21.8 108 | 18.3 90.8 | LWLF 14...B |
| | M 4 Through | — | (not appended) ⁽²⁾ | | | LWLF 14...N | | | | | | |
| 7 | 3.5 | 6.5 | 4.5 | 15 | 30 | Hexagon socket head bolt M3 × 8 | 1 360 | 2 200 | 20.1 | 5.8 37.2 | 4.8 31.3 | LWLF 18...B |
| | M 4 Through | — | (not appended) ⁽²⁾ | | | LWLF 18...N | | | | | | |
| | 3.5 | 6.5 | 4.5 | | | Hexagon socket head bolt M3 × 8 | 2 010 | 3 960 | 36.2 | 17.5 93.4 | 14.7 78.4 | LWLF 18...B |
| | M 4 Through | — | (not appended) ⁽²⁾ | | | LWLF 18...N | | | | | | |
| | 3.5 | 6.5 | 4.5 | | | Hexagon socket head bolt M3 × 8 | 2 500 | 5 500 | 50.3 | 33.0 165 | 27.7 139 | LWLF 18...BCS |
| | M 4 Through | — | (not appended) ⁽²⁾ | | | LWLF 18...N | | | | | | |

Example of identification number of assembled set

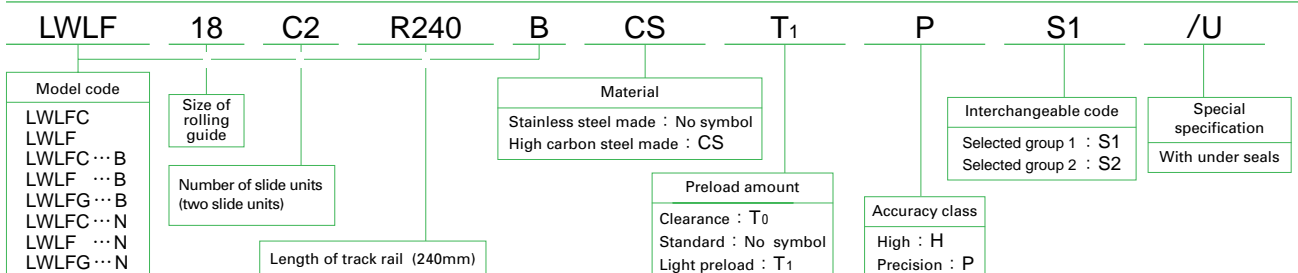

1N=0.102kgf=0.2248lbs.
1mm=0.03937inch

IKO Linear Way L: Wide rail type

LWLFC, LWLF, LWLFG

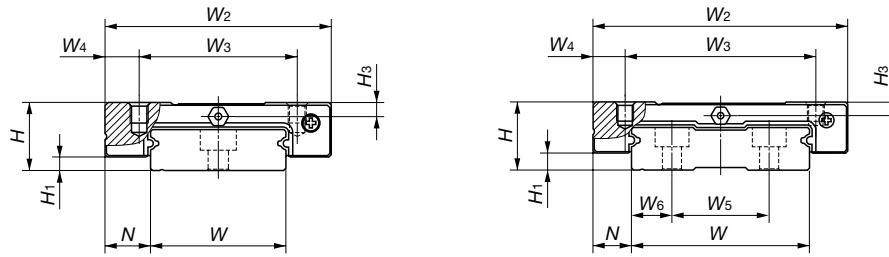

LWLFC 42...B
LWLF 42...B (CS)
LWLFG 42...B

| Model number | Interchangeable | Mass (Ref.) g | | Dimensions of assembly mm | | | Dimensions of slide unit mm | | | | | | | | | | |
|---------------|-----------------|------------------|----------------------------|---------------------------------|----------------|----|-----------------------------|----------------|----------------|----------------|----------------|----------------|----------------|------------------------|----------------|----|----------------|
| | | Slide unit | Track rail (per 100 mm) | H | H ₁ | N | W ₂ | W ₃ | W ₄ | L ₁ | L ₂ | L ₃ | L ₄ | M ₁ × depth | H ₃ | W | H ₄ |
| LWLFC 24...B | ☆ | 45 | 139 | 14 | 3 | 8 | 40 | 28 | 6 | 30.5 | — | 17.7 | — | M3 × 3.5 | 3.2 | 24 | 8 |
| LWLF 24...B | ☆ | 76 | | | | | | | | 44 | 15 | 31 | | | | | |
| LWLF 24...BCS | ☆ | 111 | | | | | | | | 59 | 28 | 46.3 | | | | | |
| LWLFG 24...B | ☆ | 70 | | | | | | | | 35.5 | — | 20.5 | | | | | |
| LWLFC 30...B | ☆ | 70 | 198 | 15 | 3 | 10 | 50 | 35 | 7.5 | 35.5 | — | 20.5 | 40 | M4 × 4.5 | 3.1 | 30 | 9 |
| LWLF 30...B | ☆ | 112 | | | | | | | | 50 | 18 | 34.8 | 54 | | | | |
| LWLF 30...BCS | ☆ | 170 | | | | | | | | 68.5 | 35 | 53.8 | 73 | | | | |
| LWLFG 30...B | ☆ | 170 | | | | | | | | 68.5 | 35 | 53.8 | 73 | | | | |
| LWLFC 42...B | ☆ | 95 | 294 | 16 | 4 | 9 | 60 | 45 | 7.5 | 41.5 | — | 25.3 | 46 | M4 × 4.5 | 3.2 | 42 | 10 |
| LWLF 42...B | ☆ | 140 | | | | | | | | 55 | 20 | 39 | 60 | | | | |
| LWLF 42...BCS | ☆ | 204 | | | | | | | | 74.5 | 35 | 58.3 | 79 | | | | |
| LWLFG 42...B | ☆ | 204 | | | | | | | | 74.5 | 35 | 58.3 | 79 | | | | |

Note(1): Track rail lengths *L* are shown in Table 17.

(2): The directions of basic dynamic load rating (*C*), basic static load rating (*C₀*), and static moment rating (*T₀*, *T_x*, and *T_y*) are shown in the sketches below.

The upper values in the *T_x* and *T_y* columns apply to one slide unit, and the lower values apply to two slide units in close contact.

Remarks 1. The mark ☆ indicates that interchangeable specification products are available.

2. The appended bolts for mounting track rails are hexagon socket head bolts of JIS B 1176 or equivalent, or cross recessed head screws for precision equipment. For stainless steel series Linear Way L, stainless steel bolts or screws are appended.

3. An oil hole is provided for LWLFC 24...B, LWLF 24...B, LWLF 24...BCS, and LWLFG 24...B.

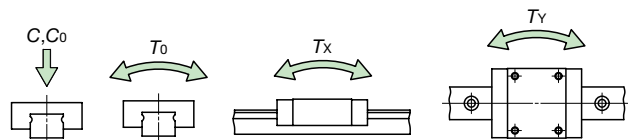

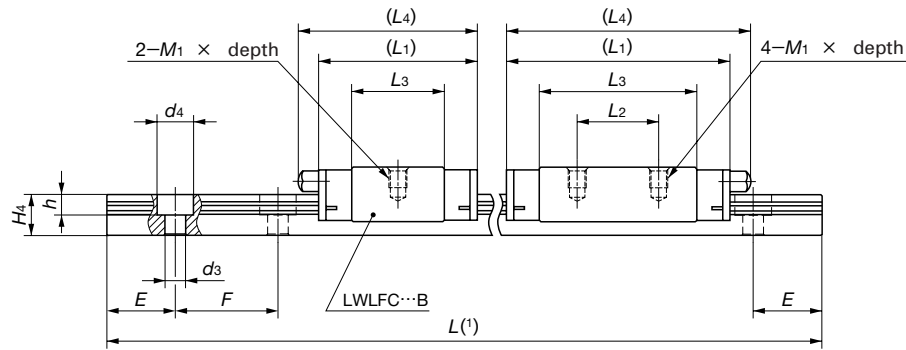

| Dimensions of track rail mm | | | | | | | | Appended mounting bolt for track rail mm Bolt size \times ℓ | Basic dynamic load rating ⁽²⁾ C N | Basic static load rating ⁽²⁾ C ₀ N | Static moment rating ⁽²⁾ | | | Model number |
|-----------------------------|-------|-------|-------|-----|-----|-----|-----------------|---|--|--|-------------------------------------|--------------|-----------------------|--------------|
| W_5 | W_6 | d_3 | d_4 | h | E | F | T_0 N-m | | | | T_x N-m | T_y N-m | | |
| - | - | 4.5 | 8 | 4.5 | 20 | 40 | M4 \times 10 | 2 500 | 3 460 | 42.2 | 10.1 70.2 | 8.5 58.9 | LWLFC 24 ... B | |
| | | | | | | | | 3 780 | 6 430 | 78.4 | 31.8 174 | 26.7 146 | LWLF 24 ... B | |
| | | | | | | | | 4 870 | 9 400 | 115 | 65.6 333 | 55.0 280 | LWLFG 24 ... B | |
| - | - | 4.5 | 8 | 4.5 | 20 | 40 | M4. \times 12 | 3 460 | 4 710 | 71.6 | 16.0 111 | 13.4 93.2 | LWLFC 30 ... B | |
| | | | | | | | | 5 230 | 8 750 | 133 | 50.5 269 | 42.4 226 | LWLF 30 ... B | |
| | | | | | | | | 6 730 | 12 800 | 194 | 104 526 | 87.4 442 | LWLFG 30 ... B | |
| 23 | 9.5 | 4.5 | 8 | 4.5 | 20 | 40 | M4 \times 12 | 4 450 | 6 280 | 133 | 25.7 170 | 21.6 143 | LWLFC 42 ... B | |
| | | | | | | | | 6 150 | 10 200 | 216 | 63.6 346 | 53.3 290 | LWLF 42 ... B | |
| | | | | | | | | 7 910 | 14 900 | 316 | 131 668 | 110 561 | LWLFG 42 ... B | |

Example of identification number of assembled set

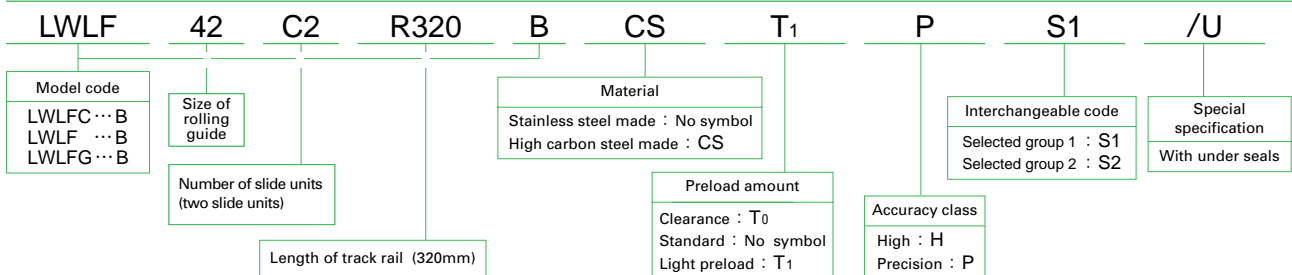

NIPPON THOMPSON CO., LTD.

Although all data in this catalog has been carefully compiled to make the information as complete as possible, NIPPON THOMPSON CO., LTD. shall not be liable for any damages whatsoever, direct or indirect, based upon any information in this catalog. NIPPON THOMPSON CO., LTD. makes no warranty, either express or implied, including the implied warranty of merchantability or fitness for a particular purpose.