

# CRANE

## FLUID SYSTEMS

Products are available from  
**MARYLAND METRICS**

P.O. Box 261 Owings Mills, MD 21117 USA

ph: (410)358-3130 (800)638-1830

fx: (410)358-3142 (800)872-9329

web: <http://mdmetric.com> email: [sales@mdmetric.com](mailto:sales@mdmetric.com)

RFQ form: <http://mdmetric.com/rfq.htm>

# PIPE FITTINGS CATALOGUE



OUR GENIUS IS FITTINGS

**CRANE**

BUILDING SERVICES & UTILITIES

## CONTENTS

Pages 1 to 7 Specification

Pages 8 to 29 Malleable iron pipe fittings

Pages 30 to 34 Bronze pipe fittings

## Crane Taper Thread Pipe Fittings

Pipe threads on Crane Pipe Fittings are British Standard taper to BS EN 10226-2 which replaces BS21 (ISO7-1) unless otherwise stated.

Crane Taper Thread Fittings offer installers numerous advantages:

- **Full engagement the whole thread length -  
*reliable strong joints***
- **No need for hemp filler -  
*fast installation, low costs***
- **High torques can be applied without risk of  
damaging the fitting**
- **Freedom to break and re-make joints**
- **Professional joint appearance**



FM311



BS EN 10242  
BS143 & 1256



## SPECIFICATION

### Pipe threads

The machined threads of Crane fittings are supplied to conform with the gauging requirements of BS EN 10226-2 and BS 21. Threads on all fittings are chamfered to assist assembly and avoid 'cross threading'. Female fittings have a chamber behind the thread, permitting the male thread to be assembled without restriction or 'bottoming'.

### Design standards

ISO 49 : 1994 is the international standard for "Malleable cast iron fittings threaded to ISO 7-1. This standard was revised in December 1994 and, compared with the 1983 edition, contained some technical revisions relating to use of alternative ferrous materials, hot dip zinc coatings, dispatch condition, pressure/temperature ratings, acceptance tests, marking and quality assurance. BS EN 10242 : 1995 is the new British European Standard for "Threaded pipe fittings in malleable cast iron" first published in August 1995 and very closely follows ISO 49 : 1994, the main difference being the inclusion of two informative annexes relating to "Assessment of conformity" and the "Relationship with the essential requirements of the Construction Products Directive (84/106/EEC)".

All European Standards have to be adopted by the member countries of the EU and any conflicting national standards withdrawn. BS143 and 1256: 2000 has been retained to cover those fittings not in BS EN 10242. It should also be noted that BS EN 10242 details a number of fitting types and sizes which were not included in BS 143 & 1256 because they were not in regular demand and/or not available from UK manufacturers. BS 143 & 1256 : 2000 specifies requirements for the design and performance of "Malleable cast iron and cast copper alloy threaded pipe fittings" and has developed over many years. BS 143 was first published in 1922 and BS 1256 in 1945, subsequently the two standards were combined in 1968. The BS 143 design requires fittings to have taper external threads and taper internal threads conforming to BS EN 10226 whereas the BS 1256 design has taper external threads and parallel internal threads. The 1986 revision was more closely related to ISO 49 : 1983 and more accurately reflected the ranges of fittings available from UK manufacturers. BS 143 & 1256 has always been technically more demanding than ISO 49 and consequently BS EN 10242.

BS 143 & 1256 were amended in August 1995 to delete those fittings now covered by BS EN 10242, so the scope of BS 143 & 1256 is now essentially : (a) BS 143 design and BS 1256 design fittings in malleable iron not covered by BS EN 10242, (b) BS 143 design fittings threaded to ANSI B1.20.1 (NPT) and (c) BS 143 design fittings made in cast copper alloy (bronze) material.

### Conformance of Crane fittings

Both malleable iron and steel fittings have been verified by the British Standards Institute (BSI) as conforming to BS EN 10242 and BS143 & 1256, as appropriate, and as such are permitted to bear the British Standards Kitemark Logo - Kitemark Licence No. KM00382.

Some small size fittings are manufactured in steel and will conform to BS EN 10241.

### The Pressure Equipment Directive 97/23/EC (PED)

The Directive applies to the design, manufacture and conformity of pressure equipment and assemblies of pressure equipment with a maximum allowable pressure greater than 0.5 bar. Individual piping components, such as fittings, are excluded from the scope of the Directive and therefore cannot be CE marked. However Crane manufactured pipe fittings are

manufactured to the appropriate European standards and satisfy the essential safety requirements of the PED.

A "Certificate of Incorporation for Pipe Fittings" can be accessed on the Crane website, or will be provided on request from Crane.

## Piping installation

Compiled from British and International standards on Pipe Threads BS EN 10226 (supercedes BS21) and Pipe Fittings standards BS EN 10242, BS 143 & 1256 and ISO 49.

Much unnecessary labour and creation of random lengths of pipe might be saved by the application of a few simple figures by the engineer when erecting the pipe line. Generally the pipe line, section by section, is either accommodated within fixed limits, usually the lines of building construction, or is fixed by prescribed dimensions. Except in the case of a continuous run of piping connected either by sockets or flanges, the engineer needs to know the length of pipe required to make up between fixed positions of fittings prior to cutting and threading.

The diagram below and table of 'A' dimensions indicates the length of thread engagement of BS EN 10226 taper pipe threads in nominal sizes 1/8 to 6 inch.

The approximate pipe length is calculated by using the expression  $L = C - (B1 + B2) + 2A$ .

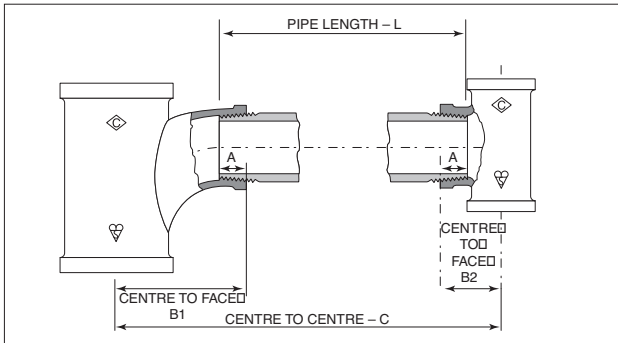

## 'A' Dimension information

Fitting size inches	A (mm)
1/8	7
1/4	10
3/8	10
1/2	13
3/4	15
1	17
1 1/4	19

Fitting size inches	A (mm)
1 1/2	19
2	24
2 1/2	27
3	30
4	36
5	40
6	40

Dimensions given do not allow for tapping or threading tolerances.

## Pipe ends

Users are advised to ensure that the external threads on the pipe being screwed into Crane fittings are free from damage or any malformation and conform to the gauging requirements of BS EN 10226.

**CRANE**®

## SPECIFICATION

### ISO – BS EN – BS identification symbols

Symbol	Type	Crane Fig. No.	
		Mall.	Bronze
A1	Elbows	151	J51
A1/45°		155	J55
A4		152	J53
B1	Tees	161	J61
-		163	-
C1	Crosses	171	J71
D1	Bends	193	-
D4		192	-
D4/45°		156	-
-		191	-
E1	Pitcher tees	199	-
E2	Twin elbows	197	-
Kb1	Return bends	213	-
-	Sockets	176	J76
M2		177	-
M2		179	J79
M3		180	-
N4	Bushes	140	J40
N8	Nipples	144	J44
N8		145	J45
P4	Back nuts	150	J50
T2	Caps	185	J85
T8	Plugs	147	-
T8		148	J48
T9		146	-
T11		149	J49
U1	Unions	241	
U11		256	J256
U11		271	
U11		289	-
U12		257	-
U12		272	-
UA11	Elbow	261	-
UA11	Unions	276	-
UA12		262	-
UA12		277	-

The symbols shown in the above table are those given in BS 143 & 1256, BS EN 10242 and ISO 49 for malleable iron fittings and in BS 143 & 1256 for copper alloy fittings, and relate to the identification of fitting types.

## Designation of fitting size

The designation of fitting size for the fittings shown in this catalogue is as follows:

**EQUAL FITTINGS:** Equal fittings where all outlets are the same size are designated by that one size, irrespective of the number of outlets.

**UNEQUAL FITTINGS:** Unequal fittings (reducing or enlarging) are specified by the sizes of each outlet, the sequence being dependent on the number of outlets:

- (a) For fittings having two outlets, the larger outlet is specified first.

Example: Fig. No. 145 hexagon reducing nipple with one end threaded size 2 and other end threaded size 1, is designated 2 x 1

- (b) For fittings having more than two outlets. Crane uses BS EN 10242 method (b) which gives the run as the first and second sizes of the designation and the branch as the third size of the designation.

This is in contrast to BS EN 10242 method (a) which gives the run as the first and third sizes of the designation and the branch as the second size of the designation. This method is used in certain international markets. (Please see the diagrams below for a visual explanation).

BS EN 10242 method (a) equivalents are specified in this catalogue where applicable.

UK method  
BSEN 10242 and ISO 49  
Method (b)  
as used by Crane.

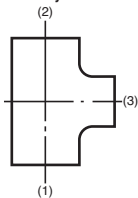

Fig. No. 161 tees

International method  
BSEN 10242 and ISO 49  
Method (a)

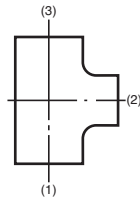

Fig. No. 161 tees

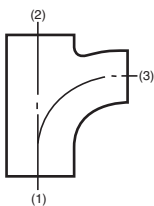

Fig. No. 199 pitcher tees

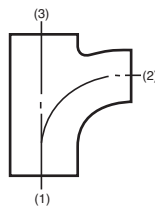

Fig. No. 199 pitcher tees

## SPECIFICATION

### Malleable cast iron

Crane malleable iron is of the Blackheart type ideally suited to pipe fitting and manufacture and conforms to BS EN 1562 Designation EN-GJMB-300-6, ASTM A197 and ISO 5922.

Typical properties of Crane malleable iron are given in the table below, exceeding the requirements in the above BS EN, ASTM and ISO standards.

Chemical composition	Typical	Mechanical properties	Typical
Total carbon	2.7%	Tensile strength (N/mm <sup>2</sup> )	340
Silicon	1.75%	Elongation on 36mm (%)	12
Manganese	0.69%	Izod impact (room temp.) (J)	12
Sulphur	0.18%	Brinell hardness	125
Phosphorous	0.02%	Density (g/cm <sup>3</sup> )	7.56

The close relationship between the physical properties of test bars and actual castings ensures design integrity and the preservation of high safety factors. Shock pressures within pipe systems can be tolerated with complete safety.

The corrosion resistance of Crane malleable iron is good when compared with grey cast iron and mild steel for most general applications including water, gas and steam.

### Crane bronze

Crane bronze has very good resistance to corrosion by aggressive waters, steam and other fluids which promote dezincification in certain copper alloys. It is also suitable for a wide range of temperatures.

### Mild steel

BS143 and 1256 allow small size (% and smaller) straight fittings to be supplied in other ferrous materials e.g. mild steel as an alternative to malleable cast iron, providing the mechanical properties are at least equivalent to the specified grade of malleable iron.

Individual data pages state which Crane fittings are supplied in mild steel.

### Galvanising

Where additional resistance to corrosion is required, malleable cast iron fittings can be hot-dip zinc coated (galvanised) prior to machining. This process involves coating the fittings with zinc which, in addition to its natural resistance to corrosion, provides electro-chemical protection where the iron of the fitting is exposed by damage. Mild steel fittings can be supplied with a proprietary zinc based coating.

The coating weight on Crane galvanised fittings conforms to the requirements of BS EN ISO 1461 1998 and ASTM 153 with a minimum coating of 610 g/m<sup>2</sup> (2oz/ft<sup>2</sup>) equal to a thickness of 86µm (0.0034 in). Average coatings are well in excess of this and exceed the requirements given in BS EN 10242 and ISO 49.

When ordering galvanised or zinc coated fittings add the suffix 'G' to the figure number.

SPECIFICATION

Pressure/Temperature ratings

BS 143 & 1256 : 1986 states that fittings are for general purposes for the transmission of fluids within the pressure and temperature ranges specified. The ratings given are updated from those in the 1968 edition, both for malleable cast iron and bronze fittings.

The graph below shows the BS pressure temperature ratings. Crane malleable iron and bronze fittings are suitable for use at these new ratings with the exception of certain unions (see note Ø below), but such use is dependent on the suitability of the connecting pipe material, the threaded joint and any thread sealants used. Due consideration should also be given to any applicable codes of practice. Pressures stated are maximum non-shock gauge.

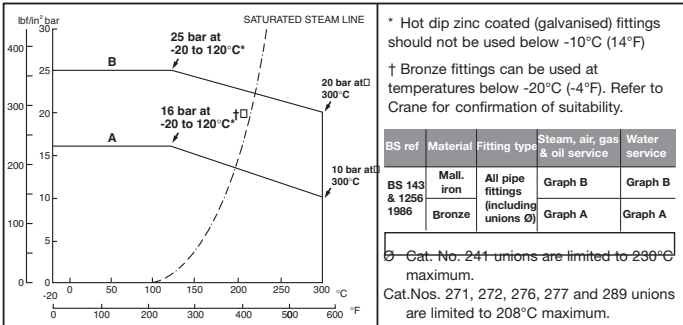

Testing

Production testing: Meets requirements of BS EN 10242 or BS 143 and 1256 as applicable. Type testing: In addition to production testing, all pressure containing fittings are required by BS EN 10242, BS 143 & 1256 and ISO 49 to be designed to withstand specified design test pressures and to be type tested accordingly - 100 bar (1450 lbf/in²) for sizes 4 and smaller malleable iron fittings, 64 bar (928 lbf/in²) for sizes 5 and 6 malleable iron and all sizes bronze fittings. Tests carried out show that production fittings have safety margins well in excess of the BS requirement. Some typical burst tests on Crane fittings illustrate their capabilities - size ½ Fig. No. 193 bend tested to 550 bar (8000 lbf/in²) without failure; size 1 Fig. No. 241 flat seat union tested to 248 bar (3600 lbf/in²) without failure; size 6 Fig. No. 151 elbow tested to 190 bar (2750 lbf/in²) without failure.

Finish

All malleable iron fittings are given an oil finish as protection against rust while in stock or during transit and after installation prior to plant commissioning. Finished fittings are free of any polycyclic aromatic hydrocarbons.

Marking

All Crane fittings are marked with the  logo and where size permits, the fitting size and Kitemark symbol. In addition, some castings also display a pattern identification number. This is normally located next to the band of the fitting. This number is used during the manufacturing process as part of the rigorous quality control procedures to ensure consistent high quality castings. The number is not of relevance to the end user of the product.





## MALLEABLE IRON PIPE FITTINGS







































Fig No. 140  HEXAGON BUSH	Fig No. 144  HEXAGON NIPPLE	Fig No. 145  HEXAGON NIPPLE REDUCING	Fig No. 146  BEADED PLUG SOLID	Fig No. 147  PLAIN PLUG HOLLOW
Fig No. 148  PLAIN PLUG SOLID	Fig No. 149  COUNTERSUNK PLUG	Fig No. 150  BACKNUT PARALLEL THREAD TO BS 2779 (ISO 228-1)	Fig No. 151  ELBOW	Fig No. 152  M & F ELBOW
Fig No. 155  45° ELBOW	Fig No. 156  45° M & F ELBOW	Fig No. 161  TEE	Fig No. 163  M & F TEE	Fig No. 171  CROSS
Fig No. 176  SOCKET PARALLEL THREAD TO BS 2779 (ISO 228-1)	Fig No. 177  SOCKET TAPER THREAD	Fig No. 179  SOCKET REDUCING	Fig No. 180  ECCENTRIC SOCKET	Fig No. 185  CAP
Fig No. 191  MALE BEND	Fig No. 192  M & F BEND	Fig No. 193  BEND	Fig No. 197  TWIN ELBOW	Fig No. 199  PITCHER TEE
Fig No. 213  RETURN BEND	Fig No. 233  ROUND FLANGE	Fig No. 241  UNION FLAT SEAT	Fig No. 256  UNION SPHERICAL SEAT IRON TO IRON	Fig No. 257  M & F UNION SPHERICAL SEAT IRON TO IRON
Fig No. 261  ELBOW UNION SPHERICAL SEAT IRON TO IRON	Fig No. 262  M & F ELBOW UNION SPHERICAL SEAT IRON TO IRON	Fig No. 271  UNION SPHERICAL SEAT BRONZE TO IRON	Fig No. 272  M & F UNION SPHERICAL SEAT BRONZE TO IRON	Fig No. 276  ELBOW UNION SPHERICAL SEAT BRONZE TO IRON
Fig No. 277  M & F ELBOW UNION SPHERICAL SEAT BRONZE TO IRON	Fig No. 289  UNION SPHERICAL SEAT BRONZE TO BRONZE	Fig No. 290  UNION SELF ALIGNING (SA)		

FIG. NO. 140 • HEXAGON BUSH PN 25

\* Supplied in mild steel.

FITTING SIZE	DIMENSIONS		WEIGHT kg PER 100 PIECES
	a (mm)	f (mm)	
* ¼ x ¼	14	16	1.14
* ⅜ x ⅜	19	19	2.51
* ⅜ x ¼	19	19	1.60
½ x ½	24	24	4.05
* ½ x ¼	24	24	3.64
½ x ⅜	24	24	3.05
¾ x ¼	26	30	7.56
¾ x ¼	26	30	6.82
¾ x ⅜	26	30	6.51
¾ x ½	26	30	5.30
1 x ¼	29	36	11.67
1 x ⅜	29	36	11.45
1 x ½	29	36	10.19
1 x ¾	29	36	8.20
1¼ x ¼	31	46	17.72
1¼ x ⅜	31	46	19.42
1¼ x ½	31	46	18.65
1¼ x ¾	31	46	16.97
1¼ x 1	31	46	14.17
1½ x ¼	31	52	23.72
1½ x ⅜	31	52	23.96
1½ x ½	31	52	25.18
1½ x ¾	31	52	23.45
1½ x 1	31	52	20.82
1½ x 1¼	31	52	13.62
2 x ⅜	35	64	40.42
2 x ½	35	64	36.35
2 x ¾	35	64	40.14
2 x 1	35	64	41.41
2 x 1¼	35	64	35.60
2 x 1½	35	64	29.67
2½ x ½	40	79	61.02
2½ x ¾	40	79	59.74
2½ x 1	40	79	60.61
2½ x 1¼	40	79	61.02
2½ x 1½	40	79	63.49
2½ x 2	40	79	49.14
3 x ½	44	93	85.28
3 x ¾	44	93	85.49
3 x 1	44	93	86.50
3 x 1¼	44	93	87.70
3 x 1½	44	93	89.15
3 x 2	44	93	90.90
3 x 2½	44	93	61.76

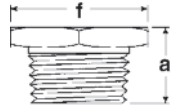

MALLEABLE IRON PIPE FITTINGS



PN 25 FIG. NO. 140 • HEXAGON BUSH

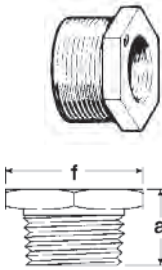

FITTING SIZE	DIMENSIONS		WEIGHT kg PER 100 PIECES
	a (mm)	f (mm)	
4 x 1	51	118	149.45
4 x 1¼	51	118	146.62
4 x 1½	51	118	150.38
4 x 2	51	118	151.41
4 x 2½	51	118	157.69
4 x 3	51	118	138.64
5 x 4	58	144	210.33
6 x 2	61	171	352.70
6 x 3	61	171	369.67
6 x 4	61	171	359.47

FIG. NO. 144 • HEXAGON NIPPLE

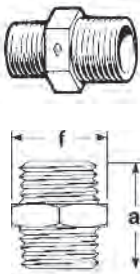

FITTING SIZE	DIMENSIONS		WEIGHT kg PER 100 PIECES
	a (mm)	f (mm)	
* ¼	33	15	2.50
* ⅜	35	18	3.91
½	44	23	6.50
¾	49	28	9.90
1	56	46	22.00
1¼	63	55	34.00
1½	63	60	42.30
2	71	72	62.70
2½	80	77	101.04
3	89	101	162.12
4	102	124	223.92
6	114	172	492.34

FIG. NO. 145 • HEXAGON NIPPLE

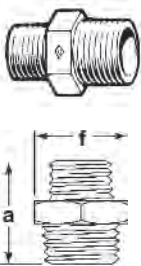

FITTING SIZE	DIMENSIONS		WEIGHT kg PER 100 PIECES
	a (mm)	f (mm)	
* ¼ x ¼	30	15	2.13
* ⅜ x ¼	35	18	4.02
½ x ¼	41	23	6.42
½ x ⅜	41	23	5.81
¾ x ¾	48	28	9.32
¾ x ½	49	28	9.67
1 x ½	56	35	15.85
1 x ¾	56	35	15.64



FIG. NO. 145 • HEXAGON NIPPLE PN 25

\* Supplied in mild steel.

FITTING SIZE	DIMENSIONS		WEIGHT kg PER 100 PIECES
	a (mm)	f (mm)	
1¼ x ½	64	44	25.03
1¼ x ¾	64	44	25.39
1¼ x 1	64	44	23.48
1½ x 1	64	50	28.94
1½ x 1¼	64	50	29.26
2 x 1	69	61	48.82
2 x 1¼	69	61	47.05
2 x 1½	71	62	49.00
2½ x 2	77	77	74.78
3 x 2	86	90	104.75
3 x 2½	85	90	109.39

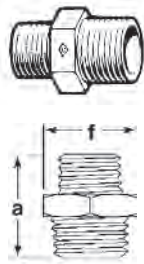

FIG. NO. 146 • BEADED PLUG – SOLID

FITTING SIZE	DIMENSIONS		WEIGHT kg PER 100 PIECES
	c (mm)	f (mm)	
¼	22	10	2.19
¾	24	10	3.40
½	33	12	6.89
¾	38	14	11.98
1	38	19	22.56
1¼	41	22	32.40
1½	45	22	46.60
2	49	26	73.44

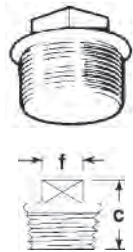
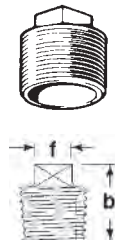
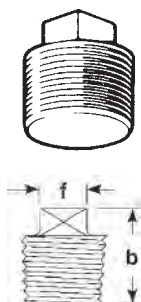

FIG. NO. 147 • PLAIN PLUG – HOLLOW

FITTING SIZE	DIMENSIONS		WEIGHT kg PER 100 PIECES
	b (mm)	f (mm)	
½	23	12	3.60
¾	26	14	5.10
1	28	18	7.95
1¼	33	24	13.50
1½	35	29	19.25
2	41	32	29.66
2½	39	35	46.31
3	44	37	71.15
4	46	44	83.28



PN 25 FIG. NO. 148 • PLAIN PLUG - SOLID



FITTING SIZE	DIMENSIONS		WEIGHT kg PER 100 PIECES
	b (mm)	f (mm)	
* 1/8	13	7	0.72
* 1/4	18	10	1.67
3/8	19	11	2.31
1/2	23	12	4.16
3/4	26	14	7.21
1	28	18	12.66
1 1/4	33	24	22.60
1 1/2	35	29	32.20
2	41	32	56.44

FIG. NO. 149 • COUNTERSUNK PLUG

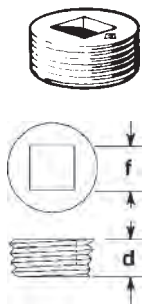

FITTING SIZE	DIMENSIONS		WEIGHT kg PER 100 PIECES
	d (mm)	f (mm)	
3/8	11	8	1.41
1/2	15	11	2.71
3/4	16	14	4.65
1	19	15	8.15
1 1/4	21	20	15.51
1 1/2	21	20	21.71
2	26	27	45.20

FIG. NO. 150 • BACKNUT



Parallel  
thread to  
BS 2779  
(ISO 228-1)



FITTING SIZE	DIMENSIONS		WEIGHT kg PER 100 PIECES
	a (mm)	f (mm)	
* 1/4	7	22	1.12
3/8	8	26	2.17
1/2	8	31	2.43
3/4	9	38	4.32
1	10	45	6.40
1 1/4	11	55	9.68
1 1/2	12	63	13.64
2	13	76	23.38
2 1/2	13	98	30.18
3	21	109	59.84

\* Supplied in mild steel.

FITTING SIZE	DIMENSIONS		WEIGHT kg PER 100 PIECES
	a (mm)	b (mm)	
Equal			
1/8	19	19	3.12
1/4	21	21	4.08
3/8	25	25	5.91
1/2	28	28	10.80
3/4	33	33	16.70
1	38	38	25.70
1 1/4	45	45	41.40
1 1/2	50	50	51.60
2	58	58	82.30
2 1/2	69	69	134.40
3	78	78	190.60
4	96	96	287.78
5	115	115	500.57
6	131	131	700.00
Reducing			
3/8 x 1/4	23	23	5.47
1/2 x 1/4	25	25	8.00
1/2 x 3/8	26	26	9.10
3/4 x 1/2	30	31	13.20
1 x 1/2	32	34	18.50
1 x 3/4	35	36	22.00
1 1/4 x 1/2	36	41	26.80
1 1/4 x 3/4	36	41	29.10
1 1/4 x 1	42	46	31.98
1 1/2 x 3/4	39	44	31.98
1 1/2 x 1	42	46	38.70
2 x 1	44	51	50.82
2 x 1 1/2	52	55	67.53

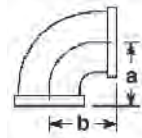

PN 25 FIG. NO. 152 • M & F ELBOW

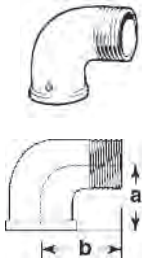

FITTING SIZE	DIMENSIONS		WEIGHT kg PER 100 PIECES
	a (mm)	b (mm)	
Equal			
1/8	19	25	2.60
1/4	21	28	4.34
3/8	25	32	6.36
1/2	28	37	8.76
3/4	33	43	15.97
1	38	52	25.34
1 1/4	45	60	36.30
1 1/2	50	68	44.81
2	58	74	83.02
2 1/2	69	88	124.48
3	78	98	169.95
4	96	118	301.79
Reducing			
3/4 x 1/2	30	40	10.58
1 x 1/2	32	51	16.20
1 x 3/4	35	46	21.40

FIG. NO. 155 • 45° ELBOW

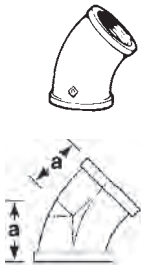

FITTING SIZE	DIMENSIONS		WEIGHT kg PER 100 PIECES
	a (mm)		
1/4	19		4.36
3/8	20		5.44
1/2	22		7.97
3/4	25		11.80
1	28		18.13
1 1/4	33		27.84
1 1/2	36		39.39
2	43		62.64
2 1/2	50		97.34
3	55		156.90
4	66		257.09
6	88		609.25

FIG. NO. 156 • 45° M & F BEND PN 25

FITTING SIZE	DIMENSIONS		WEIGHT kg PER 100 PIECES
	a (mm)	b (mm)	
¼	19	19	3.19
⅜	21	21	4.79
½	22	28	7.58
¾	29	29	12.57
1	35	35	20.39
1¼	42	42	31.48
1½	48	48	44.04
2	55	55	66.83
2½	61	61	108.97
3	68	68	138.64
4	87	87	296.23

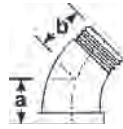

MALLEABLE IRON PIPE FITTINGS

FIG. NO. 161 • TEE

FITTING SIZE		DIMENSIONS		WEIGHT kg PER 100 PIECES
BSEN 10242		a	b	
method (b)	method (a)	(mm)	(mm)	
<b>Equal</b>				
¼		19	19	4.02
¼		21	21	5.43
⅜		25	25	7.81
½		28	28	14.40
¾		33	33	23.50
1		38	38	35.60
1¼		45	45	58.90
1½		50	50	69.30
2		58	58	108.40
2½		69	69	189.40
3		78	78	216.09
4		96	96	395.11
5		115	115	651.99
6		131	131	1023.00
<b>Reducing on branch</b>				
¾ x ¼		23	23	7.55
½ x ¼		24	24	11.97
½ x ⅜		26	26	12.40
¾ x ¼		26	27	13.72
¾ x ⅜		28	28	17.70
¾ x ½		30	31	20.20
1 x ¼		28	31	19.16
1 x ⅜		32	35	24.44
1 x ½		32	35	27.10
1 x ¾		35	36	28.50
1¼ x ½		34	38	37.00
1¼ x ¾		36	41	43.17
1¼ x 1		40	42	46.20

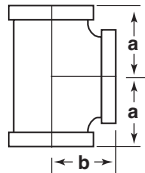
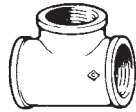



PN 25 FIG. NO. 161 • TEE

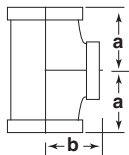
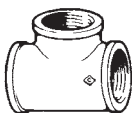

FITTING SIZE		DIMENSIONS		WEIGHT kg PER 100 PIECES
BSEN 10242		a	b	
method (b)	method (a)	(mm)	(mm)	
<b>Reducing on branch</b>				
1½ x ½		36	42	45.40
1½ x ¾		38	44	47.80
1½ x 1		42	46	54.60
1½ x 1¼		46	48	61.50
2 x ½		38	48	60.89
2 x ¾		40	50	62.58
2 x 1		44	52	77.30
2 x 1¼		48	54	84.80
2 x 1½		52	55	93.50
2½ x ½		41	57	84.87
2½ x ¾		44	59	109.90
2½ x 1		47	60	105.78
2½ x 1¼		52	62	114.33
2½ x 1½		55	63	139.77
2½ x 2		61	66	143.60
3 x ½		51	68	156.96
3 x ¾				147.19
3 x 1				143.10
3 x 1¼		55	70	169.70
3 x 1½		58	71	177.60
3 x 2		64	73	192.40
3 x 2½		72	76	228.60
4 x 1		56	81	204.76
4 x 1¼		61	83	220.42
4 x 1½		64	84	255.03
4 x 2		70	86	250.08
4 x 2½		77	89	376.36
4 x 3		84	92	315.18
6 x 3		92	121	676.71
6 x 4		105	125	748.30

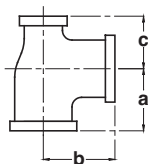

FITTING SIZE		DIMENSIONS			WEIGHT kg PER 100 PIECES
BSEN 10242		a	b	c	
method (b)	method (a)	(mm)	(mm)	(mm)	
<b>Reducing on run</b>					
½ x ¼ x ½	½ x ½ x ¼	28	28	25	12.26
¾ x ½ x ¾	¾ x ¾ x ½	33	33	31	22.00
1 x ½ x 1	1 x 1 x ½	38	38	34	24.75
1 x ¾ x 1	1 x 1 x ¾	38	38	36	27.51
1¼ x ½ x 1¼	1¼ x 1¼ x ½	45	45	38	38.32
1¼ x ¾ x 1¼	1¼ x 1¼ x ¾	45	45	41	41.69
1¼ x 1 x 1¼	1¼ x 1¼ x 1	45	45	42	46.70
1½ x ½ x 1½	1½ x 1½ x ½	50	50	44	58.00
1½ x ¾ x 1½	1½ x 1½ x ¾	50	50	44	49.50
1½ x 1 x 1½	1½ x 1½ x 1	50	50	46	60.62

**CRANE**®

FITTING SIZE		DIMENSIONS			WEIGHT kg PER 100 PIECES
BSEN 10242		a	b	c	
method (b)	method (a)	(mm)	(mm)	(mm)	
<b>Reducing on run</b>					
2 x ½ x 2	2 x 2 x ½	58	58	52	79.77
2 x ¾ x 2	2 x 2 x ¾	58	58	52	88.60
2 x 1 x 2	2 x 2 x 1	58	58	52	92.80
2 x 1½ x 2	2 x 2 x 1½				102.60
2½ x 1½ x 2½	2½ x 2½ x 1½	69	69	64	124.68
3 x 2 x 3	3 x 3 x 2	78	78	73	191.20
<b>Reducing on run &amp; branch</b>					
½ x ¾ x ¾	½ x ¾ x ¾	26	26	25	9.34
¾ x ½ x ½	¾ x ½ x ½	30	31	28	19.80
1 x ¾ x ½	1 x ½ x ¾	32	34	30	19.88
1 x ¾ x ¾	1 x ¾ x ¾	35	36	33	30.20
1¼ x 1 x ½	1¼ x ½ x 1	36	41	35	36.20
1¼ x 1 x ¾	1¼ x ¾ x 1	36	41	35	29.25
1¼ x 1 x 1	1¼ x 1 x 1	40	42	38	44.64
1½ x 1 x 1	1½ x 1 x 1	42	46	38	43.22
1½ x 1¼ x ½	1½ x ½ x 1¼	37	43	33	45.64
1½ x 1¼ x 1	1½ x 1 x 1¼	42	46	40	56.90
1½ x 1¼ x 1¼	1½ x 1¼ x 1¼	46	48	45	64.00
2 x 1½ x ½	2 x ½ x 1½	44	51	41	66.85
2 x 1½ x ¾	2 x ¾ x 1½	44	51	41	70.40
2 x 1½ x 1	2 x 1 x 1½	44	51	41	64.60
2 x 1½ x 1¼	2 x 1¼ x 1½	48	54	46	71.40
2 x 1½ x 1½	2 x 1½ x 1½	52	55	50	85.50

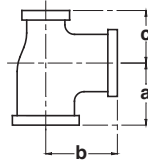
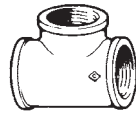

FITTING SIZE		DIMENSIONS		WEIGHT kg PER 100 PIECES
BSEN 10242		a	b	
method (b)	method (a)	(mm)	(mm)	
<b>Increasing on branch</b>				
½ x ¾		31	30	15.15
¾ x 1		36	35	26.10
1 x 1¼		42	40	35.27
1 x 1½		46	42	42.91
1¼ x 2		54	48	77.35
1½ x 2		55	52	72.68
2 x 2½		66	61	119.77

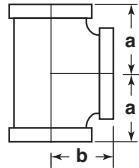

PN 25 FIG. NO. 163 • M & F TEE

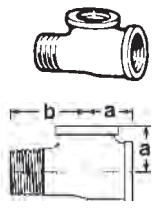

FITTING SIZE	DIMENSIONS		WEIGHT kg PER 100 PIECES
	a (mm)	b (mm)	
¼	29	41	12.36
¾	33	48	19.85
1	38	54	31.19

FIG. NO. 171 • CROSS

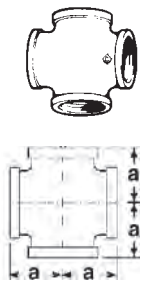

FITTING SIZE	DIMENSIONS a (mm)	WEIGHT kg PER 100 PIECES
¾	25	10.04
½	28	15.48
¾	33	21.68
1	38	37.12
1¼	45	73.60
1½	50	77.35
2	58	101.76
2½	69	165.73
3	78	233.81
4	96	447.43

FIG. NO. 176 • SOCKET

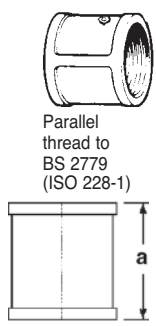

FITTING SIZE	DIMENSIONS a (mm)	WEIGHT kg PER 100 PIECES
* ¼	27	3.57
* ¾	30	4.53
½	34	6.26
¾	39	8.45
1	42	13.66
1¼	49	22.33
1½	54	29.53
2	64	41.72
2½	73	75.19
3	81	101.46
4	94	183.96



FIG. NO. 177 • SOCKET PN 25

FITTING SIZE	DIMENSIONS a (mm)	WEIGHT kg PER 100 PIECES
¼	27	3.30
⅜	30	4.17
½	34	7.90
¾	39	12.30
1	42	19.70
1¼	49	27.50
1½	54	36.20
2	64	48.99
2½	73	80.71
3	81	105.16
4	94	186.43
6	121	454.64

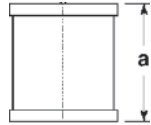
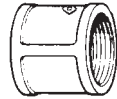
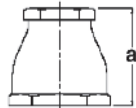
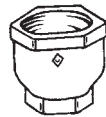

FIG. NO. 179 • REDUCING SOCKET

FITTING SIZE	DIMENSIONS a (mm)	WEIGHT kg PER 100 PIECES
Reducing		
* ⅜ x ¼	29	4.71
½ x ¼	32	7.83
½ x ⅜	32	5.26
¾ x ¼	37	13.18
¾ x ⅜	37	7.62
¾ x ½	37	14.53
1 x ¼	43	11.14
1 x ⅜	43	18.23
1 x ½	43	18.65
1 x ¾	43	19.30
1¼ x ½	52	22.23
1¼ x ¾	52	23.55
1¼ x 1	52	27.30
1½ x ½	59	28.39
1½ x ¾	59	26.35
1½ x 1	59	27.93
1½ x 1¼	59	33.23
2 x ½	71	34.98
2 x ¾	71	42.56
2 x 1	71	52.12
2 x 1¼	71	54.38
2 x 1½	71	58.61
2½ x ½	83	62.58
2½ x 1	83	64.73
2½ x 1¼	83	73.62
2½ x 1½	83	67.28
2½ x 2	83	73.24
3 x 1	94	97.80
3 x 2	94	95.53
3 x 2½	94	107.84
4 x 2	111	161.71
4 x 2½	111	178.91
4 x 3	111	201.37
6 x 4	149	443.93



**CRANE**®

PN 25 FIG. NO. 180 • ECCENTRIC SOCKET

\* Supplied in mild steel.

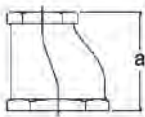
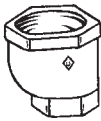

FITTING SIZE	DIMENSIONS a (mm)	WEIGHT kg PER 100 PIECES
Reducing ¾ x ½	37	13.31
1 x ½	43	12.33
1 x ¾	43	12.86
1¼ x ½	52	19.92
1¼ x ¾	52	25.03
1¼ x 1	52	22.33
1½ x ½	59	35.64
1½ x ¾	59	29.68
1½ x 1	59	38.19
1½ x 1¼	59	45.22
2 x ½	71	55.83
2 x ¾	71	57.37
2 x 1	71	56.44
2 x 1¼	71	47.42
2 x 1½	71	52.41
2½ x ½	83	86.40
2½ x 1½	83	99.56
2½ x 2	83	144.10
3 x 2	94	119.17
3 x 2½	94	113.67

FIG. NO. 185 • CAP

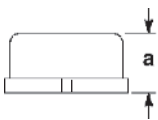

FITTING SIZE	DIMENSIONS a (mm)	WEIGHT kg PER 100 PIECES
* ¼	17	3.21
* ⅜	19	4.94
½	26	7.36
¾	27	7.18
1	32	15.75
1¼	32	20.19
1½	33	25.94
2	38	42.81
2½	41	65.46
3	44	92.65
4	52	165.83

FIG. NO. 191 • MALE BEND PN 25

FITTING SIZE	DIMENSIONS a (mm)	WEIGHT kg PER 100 PIECES
½	45	8.70
¾	50	13.60
1	63	23.82
1¼	76	42.66
1½	85	56.73
2	102	97.28

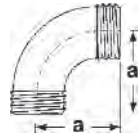
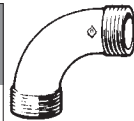

FIG. NO. 192 • M & F BEND

FITTING SIZE	DIMENSIONS a (mm)	WEIGHT kg PER 100 PIECES
¼	30	4.19
¾	36	6.97
½	45	10.87
¾	50	15.81
1	63	26.27
1¼	76	45.24
1½	85	63.45
2	102	102.54
2½	114	163.56
3	127	246.79
4	165	481.53
6	229	1125.79

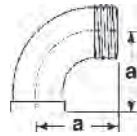
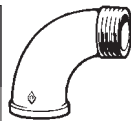
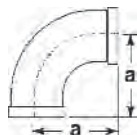
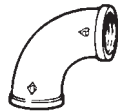

FIG. NO. 193 • BEND

FITTING SIZE	DIMENSIONS a (mm)	WEIGHT kg PER 100 PIECES
¼	30	6.32
¾	36	8.84
½	45	13.40
¾	50	19.57
1	63	32.80
1¼	76	64.84
1½	85	77.15
2	102	120.20
2½	114	191.58
3	127	270.68
4	165	486.68
5		761.17
6	229	1176.26



**CRANE**®

PN 25 FIG. NO. 197 • TWIN ELBOW

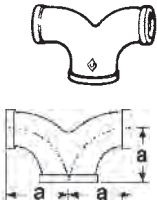

FITTING SIZE	DIMENSIONS a (mm)	WEIGHT kg PER 100 PIECES
½	45	20.68
¾	50	29.66
1	63	49.23
1¼	76	88.73
1½	85	111.14
2	102	176.75
2½	114	313.94
3	127	409.12

FIG. NO. 199 • PITCHER TEE

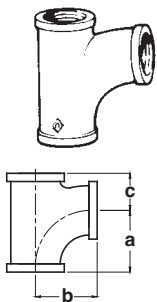

FITTING SIZE	DIMENSIONS			WEIGHT kg PER 100 PIECES
	a	b	c	
<b>BSEN 10242</b>				
method (b)				
method (a)				
Equal				
½	45	45	24	22.06
¾	50	50	28	25.45
1	63	63	33	40.46
1¼	76	76	40	70.91
1½	85	85	43	96.67
2	102	102	53	164.18
2½	114	114	61	262.01
3	127	127	70	353.91
4	165	165	87	608.73
Reducing on branch				
¾ x ½	47	48	25	21.88
1 x ½	49	51	28	29.16
1 x ¾	53	56	30	32.75
1¼ x ½	51	56	30	40.71
1¼ x ¾	55	58	33	47.43
1¼ x 1	66	68	36	57.26
1½ x ½	52	58	29	51.35
1½ x ¾	55	61	33	55.11
1½ x 1	66	71	36	65.63
1½ x 1¼	77	79	41	94.60
2 x ½	54	64	32	72.31
2 x ¾	58	67	35	84.87
2 x 1	70	77	40	96.56
2 x 1¼	80	85	45	114.79
2 x 1½	91	94	48	136.06
2½ x ½	60	75	37	115.88
2½ x ¾	60	75	37	115.22
2½ x 1	72	85	40	131.90
2½ x 1¼	83	93	45	147.50
2½ x 1½	94	103	48	182.96
2½ x 2	104	109	54	226.19

FIG. NO. 199 • PITCHER TEE PN 25

FITTING SIZE		DIMENSIONS			WEIGHT kg PER 100 PIECES
BSEN 10242		a	b	c	
method (b)	method (a)	(mm)	(mm)	(mm)	
Reducing on branch					
3 x 1½		96	109	50	232.76
3 x 2		106	116	56	266.52
4 x 2½		121	133	69	431.06
4 x 3		132	139	75	493.37
Reducing on run & branch					
¾ x ½ x ½	¾ x ½ x ½	47	48	24	20.73
1 x ¾ x ½	1 x ½ x ¾	49	51	25	26.47
1 x ¾ x ¾	1 x ¾ x ¾	53	54	28	31.11
Reducing on run					
¾ x ½ x ¾	¾ x ¾ x ½	50	50	27	25.38

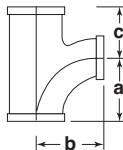
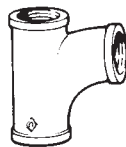
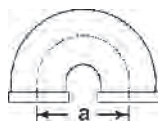

FIG. NO. 213 • RETURN BEND

FITTING SIZE	DIMENSIONS a (mm)	WEIGHT kg PER 100 PIECES
½	38	17.87
¾	51	35.71
1	64	52.22
1¼	76	92.37
1½	89	115.21
2	102	146.36





PN 25 FIG. NO. 233 • ROUND FLANGE

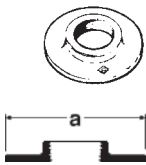

FITTING SIZE	DIMENSIONS a (mm)	WEIGHT kg PER 100 PIECES
Undrilled & unfaced		
½	95	25.75
¾	102	34.03
1	114	47.90
1¼	121	53.02
1½	133	73.13
2	152	105.27
2½	165	124.22
3	184	161.50
4	216	252.35

FIG. NO. 241 • UNION

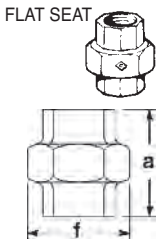

FITTING SIZE	DIMENSIONS a (mm)	f (mm)	WEIGHT kg PER 100 PIECES
½	49	42	20.44
¾	53	49	30.39
1	58	57	41.22

FIG. NO. 299 • GASKET FOR FIG. NO. 241

(compressed non-asbestos fibre)

FITTING SIZE	WEIGHT kg PER 100 PIECES
½	-
¾	-
1	-

FIG. NO. 256 • UNION

SPHERICAL SEAT – iron to iron

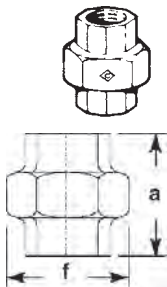

FITTING SIZE	DIMENSIONS a (mm)	f (mm)	WEIGHT kg PER 100 PIECES
¼	42	32	11.14
⅜	45	36	13.75
½	49	42	20.70
¾	53	49	30.08
1	58	57	40.75
1¼	64	68	60.67
1½	68	76	78.49
2	75	92	119.89
2½	84	111	187.05
3	92	125	248.33
4	107	155	426.52

**CRANE**®

FIG. NO. 257 • M & F UNION PN 25

FITTING SIZE	DIMENSIONS			WEIGHT kg PER 100 PIECES
	b (mm)	a (mm)	f (mm)	
¼	57	32	†	11.95
⅜	61	36	†	16.07
½	68	56	42	25.85
¾	74	74	49	36.77
1	82	57	57	50.63
1¼	91	68	†	74.26
1½	95	76	†	99.95
2	104	92	†	147.70
2½	116	111	†	232.78
3	131	125	†	324.66

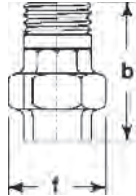
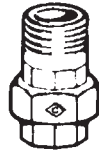

FIG. NO. 261 • ELBOW UNION

FITTING SIZE	DIMENSIONS			WEIGHT kg PER 100 PIECES
	a (mm)	c (mm)	f (mm)	
½	56	28	42	25.72
¾	64	33	49	37.31
1	72	38	57	54.38

SPHERICAL  
SEAT – iron  
to iron

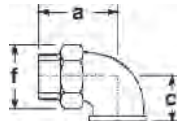
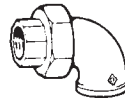
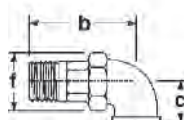
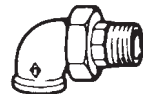

FIG. NO. 262 • M & F ELBOW UNION

FITTING SIZE	DIMENSIONS			WEIGHT kg PER 100 PIECES
	b (mm)	c (mm)	f (mm)	
½	78	28	42	29.89
¾	86	33	49	44.44
1	98	38	57	62.88

SPHERICAL  
SEAT – iron  
to iron



**CRANE**®

PN 25 FIG. NO. 271 • UNION

SPHERICAL SEAT— bronze to iron

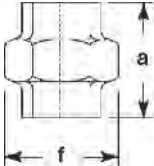
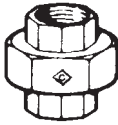

FITTING SIZE	DIMENSIONS		WEIGHT kg PER 100 PIECES
	a (mm)	f (mm)	
½	42	32	12.26
¾	42	32	11.03
¾	45	36	14.54
½	49	42	20.69
¾	53	49	30.33
1	58	57	40.79
1¼	64	68	59.64
1½	68	76	77.87
2	75	92	120.10
2½	84	111	187.15
3	92	125	247.81
4	107	155	432.60

FIG. NO. 272 • M & F UNION

SPHERICAL SEAT— bronze to iron

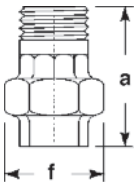
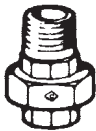

FITTING SIZE	DIMENSIONS		WEIGHT kg PER 100 PIECES
	a (mm)	f (mm)	
½	68	42	25.34
¾	74	49	37.80
1	82	57	50.99
1¼	91	68	74.16
1½	95	76	98.30
2	104	92	150.28

FIG. NO. 276 • ELBOW UNION

SPHERICAL SEAT— bronze to iron

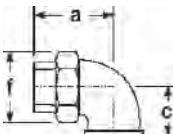
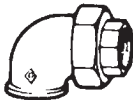

FITTING SIZE	DIMENSIONS			WEIGHT kg PER 100 PIECES
	a (mm)	c (mm)	f (mm)	
½	56	28	42	25.63
¾	64	33	49	37.27
1	72	38	57	55.00

**CRANE**®

FIG. NO. 277 • M & F ELBOW UNION PN 25

FITTING SIZE	DIMENSIONS			WEIGHT kg PER 100 PIECES
	b (mm)	c (mm)	f (mm)	
½	78	28	42	30.44
¾	86	33	49	44.17
1	98	38	57	62.98

SPHERICAL  
SEAT—  
bronze to iron

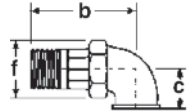
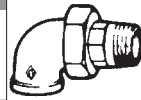

FIG. NO. 289 • UNION

FITTING SIZE	DIMENSIONS		WEIGHT kg PER 100 PIECES
	a (mm)	f (mm)	
¼	42	32	10.91
¾	45	36	14.98
½	49	42	20.97
¾	53	49	30.44
1	58	57	40.99
1¼	64	68	61.13
1½	68	76	79.78
2	75	92	121.54
2½	84	111	187.72
3	92	125	248.02

SPHERICAL  
SEAT –  
bronze to  
bronze

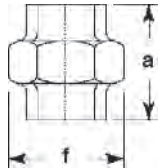
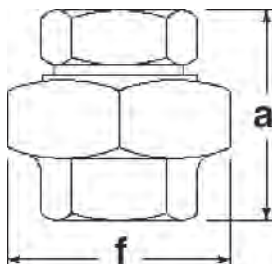

FIG. NO. 290 • UNION

FITTING SIZE	DIMENSIONS		WEIGHT kg PER 100 PIECES
	a (mm)	f (mm)	
½	49	44	22.96
¾	52	48	28.66
1	57	55	37.44
1¼	67	67	60.00
1½	78	76	94.48
2	87	90	134.79



**THE CRANE SA (SELF ALIGNING) UNION** The Crane SA Union is made with double spherical seats. Pipes which are not in alignment can be securely connected at any angle up to 6° of arc from centre line of the union, thus avoiding the need for offsets. The union provides a pressure tight joint without the use of gaskets or washers.

- Self aligning (SA) Union
- Double spherical seats
- Iron to iron seating
- Taper threads to BS 21 (ISO 7-1)
- Black or Galvanised

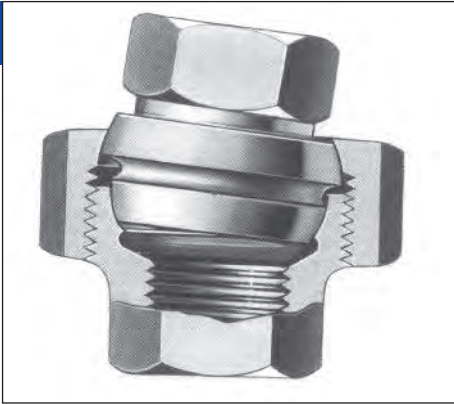

*SA Union - female*



*6° out of alignment and still pressure tight*



PN 16 BRONZE PIPE FITTINGS















Fig No. <b>J40</b>  HEXAGON BUSH	Fig No. <b>J44</b>  HEXAGON NIPPLE	Fig No. <b>J45</b>  HEXAGON NIPPLE REDUCING	Fig No. <b>J48</b>  PLAIN PLUG SOLID	Fig No. <b>J49</b>  COUNTERSUNK PLUG
Fig No. <b>J50</b>  BACKNUT PARALLEL THREAD TO BS 2779 (ISO 228-1)	Fig No. <b>J51</b>  ELBOW	Fig No. <b>J53</b>  M & F ELBOW	Fig No. <b>J61</b>  TEE	Fig No. <b>J71</b>  CROSS
Fig No. <b>J76</b>  SOCKET PARALLEL THREAD TO BS 2779 (ISO 228-1)	Fig No. <b>J79</b>  SOCKET REDUCING	Fig No. <b>J85</b>  CAP	Fig No. <b>J256</b>  STRAIGHT UNION	

FIG. NO. J40 • HEXAGON BUSH PN 16

FITTING SIZE	DIMENSIONS		WEIGHT kg PER 100 PIECES
	a (mm)	f (mm)	
¼ x ¼	15	16	1.40
⅜ x ⅜	16	18	2.34
⅜ x ¼	17	19	2.24
½ x ½	22	24	5.67
½ x ¼	22	24	3.29
½ x ⅜	22	24	3.89
¾ x ¾	25	30	6.50
¾ x ⅜	25	30	7.87
¾ x ½	25	30	6.07
1 x ½	28	36	12.98
1 x ¾	28	36	9.68
1¼ x ½	30	46	22.43
1¼ x ¾	30	46	20.91
1¼ x 1	31	46	16.48
1½ x ½	26	51	30.34
1½ x ¾	26	51	20.09
1½ x 1	26	51	24.73
1½ x 1¼	26	51	15.76
2 x 1	30	64	48.27
2 x 1¼	30	64	41.61
2 x 1½	30	64	35.52

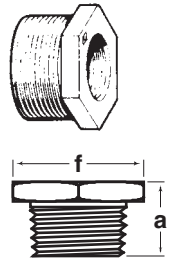

FIG. NO. J44 • HEXAGON NIPPLE

FITTING SIZE	DIMENSIONS		WEIGHT kg PER 100 PIECES
	a (mm)	f (mm)	
¼	35	17	2.68
⅜	36	21	4.45
½	44	23	5.31
¾	49	28	11.37
1	56	35	17.76
1¼	64	44	29.90
1½	64	50	38.11
2	71	6	55.35

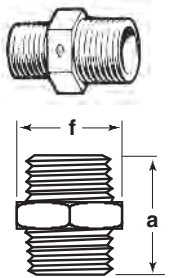
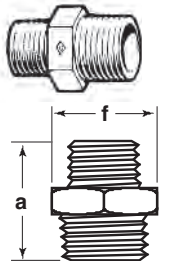

FIG. NO. J45 • HEXAGON NIPPLE

FITTING SIZE	DIMENSIONS		WEIGHT kg PER 100 PIECES
	a (mm)	f (mm)	
¼ x ¼	30	15	2.13
⅜ x ¼	35	22	3.99
½ x ⅜	38	25	4.56
¾ x ½	49	28	7.57
1 x ¾	50	38	19.32
1¼ x 1	64	44	31.62
1½ x 1¼	64	50	40.38
2 x 1½	71	62	59.84





PN 16 FIG. NO. J48 • PLAIN PLUG – SOLID

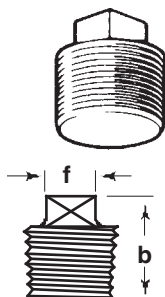

FITTING SIZE	DIMENSIONS		WEIGHT kg PER 100 PIECES
	b (mm)	f (mm)	
¼	15	7	0.71
½	21	10	1.40
¾	23	11	2.52
1	23	12	5.22
1¼	26	13	8.72
1½	28	18	17.76
2	33	24	28.10
2½	35	29	44.38
3	41	32	67.03

FIG. NO. J49 • COUNTERSUNK PLUG

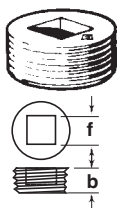

FITTING SIZE	DIMENSIONS		WEIGHT kg PER 100 PIECES
	b (mm)	f (mm)	
¾	12	8	1.53
1	16	11	3.11
1¼	17	14	5.42
1½	20	15	10.63

FIG. NO. J50 • BACKNUT

Parallel thread  
to BS 2779  
(ISO 228-1)

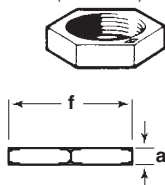

FITTING SIZE	DIMENSIONS		WEIGHT kg PER 100 PIECES
	a (mm)	f (mm)	
¼	7	22	1.97
½	8	26	3.23
¾	8	31	3.15
1	9	38	5.22
1¼	10	45	7.36
1½	11	55	11.64
2	12	63	16.07
2½	13	76	23.70

FIG. NO. J51 • ELBOW

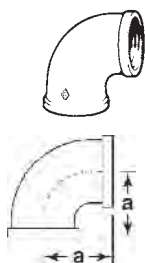

FITTING SIZE	DIMENSIONS a (mm)	WEIGHT kg PER 100 PIECES
½	21	4.94
¾	25	7.00
1	28	11.47
1¼	33	13.26
1½	38	29.21
2	45	41.20
2½	50	57.32
3	58	79.10



FIG. NO. J53 • M & F ELBOW PN 16

FITTING SIZE	DIMENSIONS		WEIGHT kg PER 100 PIECES
	a (mm)	c (mm)	
¼	21	30	4.50
⅜	24	37	7.00
½	29	41	10.46
¾	33	48	16.27
1	38	54	24.83
1¼	44	62	45.68
1½	49	68	60.26
2	60	76	92.03

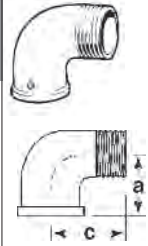

FIG. NO. J61 • TEE

FITTING SIZE	DIMENSIONS a (mm)	WEIGHT kg PER 100 PIECES
⅜	22	9.26
½	26	14.31
¾	33	22.80
1	38	37.37
1¼	45	71.17
1½	50	84.91
2	58	119.58

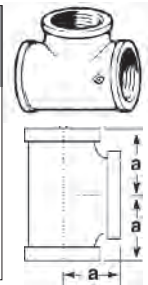

FIG. NO. J71 • CROSS

FITTING SIZE	DIMENSIONS a (mm)	WEIGHT kg PER 100 PIECES

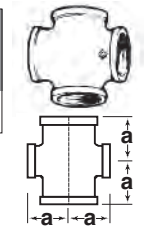
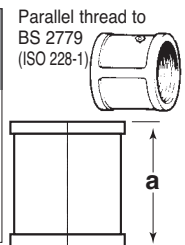
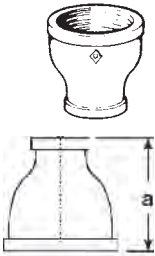

FIG. NO. J76 • SOCKET

FITTING SIZE	DIMENSIONS a (mm)	WEIGHT kg PER 100 PIECES
¼	25	4.08
⅜	28	5.27
½	34	7.21
¾	39	10.29
1	42	15.45



PN 16 FIG. NO. J79 • REDUCING SOCKET



<i>FITTING SIZE</i>	<i>DIMENSIONS a (mm)</i>	<i>WEIGHT kg PER 100 PIECES</i>
3/8 x 1/4	26	4.68
1/2 x 3/8	34	5.87
3/4 x 1/2	37	9.82
1 x 1/2	44	14.69
1 x 3/4	44	15.88

FIG. NO. J85 • CAP

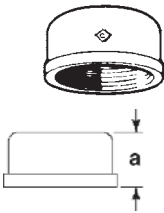

<i>FITTING SIZE</i>	<i>DIMENSIONS a (mm)</i>	<i>WEIGHT kg PER 100 PIECES</i>
1/4	17	2.69
3/8	22	5.76
1/2	26	5.46
3/4	26	9.14
1	32	14.55

FIG. NO. J256 • UNION

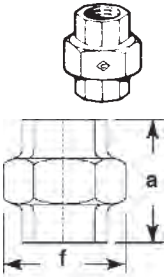

<i>FITTING SIZE</i>	<i>DIMENSIONS a (mm)</i>	<i>f (mm)</i>	<i>WEIGHT kg PER 100 PIECES</i>
1/2	42	42	22.37
3/4	47	49	29.14
1	52	57	42.35
1 1/4	56	69	67.18
1 1/2	62	76	86.31
2	65	92	135.45



## When you see these signs - you're safe



### Suitable for Use with Drinking Water



The British Standards Kitemark means that the fittings have been independently assessed by BSI to confirm compliance with the product standards - BSEN 10242 and BS143 and 1256.



Crane kitemarked fittings are deemed to satisfy the requirements of the United Kingdom Water Regulations (Byelaws).

### Taper Thread fittings



This sign means that the fitting is manufactured in the UK by Crane and has a taper thread. This ensures the fitting engages with the whole thread of the pipe which is also tapered giving a strong, reliable joint without the need for hemp filler.

**Crane Fittings carry the signs to assure you  
of the best of British manufacture.**



## **CRANE FLUID SYSTEMS**

Products are available from

### **MARYLAND METRICS**

P.O. Box 261 Owings Mills, MD 21117 USA

ph: (410)358-3130 (800)638-1830

fx: (410)358-3142 (800)872-9329

web: <http://mdmetric.com> email: [sales@mdmetric.com](mailto:sales@mdmetric.com)

RFQ form: <http://mdmetric.com/rfq.htm>

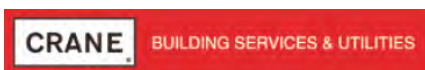

CRANE HOUSE, EPSILON TERRACE  
WEST ROAD, IPSWICH  
SUFFOLK IP3 9FJ