

Metric Spur Gears & Racks

Module Sizes 1-8



Hub Type



Plate Type



Gear Rack

Gear Rack Module Sizes



Bore Types & Options



Pilot Bore



Bored to Size with keyway & set screw



Interference fit



Keyless locking device



Weld-On Hub & Tapered Bushing



Bolt on Hub for Bushing

Applications - Linear Motion Control

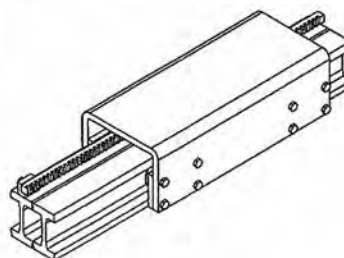
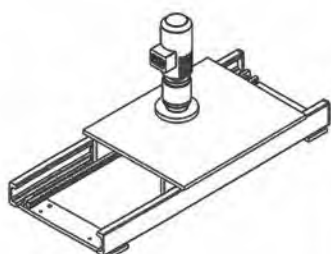

P.T. International Corp.

372

Spur Gear and Gear Rack Basics



There are a wide range of parameters that influence the selection of gears. Strength of the gear tooth is one of the most important factors. This is also known as the bending strength of the tooth as allowed by the stress at the tooth root under load from the mating gear. Surface durability is another, which can be described as the allowable tangential force transmitted safely at the pitch circle. Proper lubrication of the gears will also enhance the life of the working gears and extend service life. Selecting the proper lubricant and ensuring adequate re-lubrication is also an important consideration.

Surface speed of the mating gears is another factor to consider. Unlike enclosed gears that are typically flooded in a lubricant, open gears are more subject to contamination and less lubricant. Other factors that influence selection include operating temperature, moisture, gear alignment, duty cycle and application shock loads.



As speeds increase, whether on mating circular gears for rotational motion or for gear racks and pinion gears that create linear

motion, higher speeds may require ground gears for more precise and quiet movement. Minimizing the backlash, which is the space between the non-contact side of mating gear teeth, may require gears sets with a precision fit.

Experience also plays an important role especially when evaluating design improvements. Consider existing applications and results, concerning life and tooth wear can be a good guide to improve similar applications. Gear life is generally extended with hardened teeth, when contamination has been minimized and when proper lubrication has been maintained. Therefore, no one selection criteria can yield the ideal size, so considering all the

Gear Terms

- Addendum:** The height of the tooth measured above the pitch circle.
- Backlash:** The play (distance) between mating teeth at the pitch circle.
- Center Distance:** The distance between centers of mating gears.
- Circular Pitch:** Arc length of the pitch circle between the centers of other corresponding points of adjacent teeth. $\text{Circular Pitch} = 3.14159 / \text{Diametral Pitch}$.
- Clearance:** The radial distance or separation between the top of one tooth and the bottom of the mating tooth space.
- Crown:** The face of each gear tooth having a slight outward bulge and thinner on each end. This feature helps accommodate slight misalignments of gear teeth or shafts on which they are mounted.
- Dedendum:** The depth of the tooth measured below the pitch circle.
- Diametral Pitch:** The ratio of the number of teeth to the number of inches of pitch diameter. $\text{Diametral Pitch} = 3.14159 / \text{Circular Pitch}$.



- External Gears:** Gears with teeth cut on the outside.
- Face Width:** The axial tooth length.
- Tooth Flank:** The surface between the pitch circle and the bottom of the tooth space.
- Flank:** The working, or contacting, side of the gear tooth.
- Gear Center:** The center of the pitch circle of the gear.
- Gear Ratio:** The ratio of the number of teeth in mating gear sets. Usually it is the number of teeth in the driven gear divided by the number of teeth in driving gear.

possible application conditions will yield the best product choice. The following selection criteria will discuss typical gear tooth physical parameters and terms. These are industry standard terms, and intended to form a basis for gear selection. Gears transmit torque and can maintain a rotational or linear speed. Hence they are very popular and an inexpensive choice for power transmission or for controlling linear motion.

The gears in this catalog are 20° pressure angle and are metric by design. They are available with and without a hub and can fit onto the shaft by a variety of ways. The formulas and selection criteria will be the same regardless of whether inch or metric parameters. Metric gears are necessary for proper part replacement on European equipment and suggested for use on machinery destined for global end use markets where metric replacements may be found easier.



Hub Type

Plate Type

Typical applications include Machine Tools, Heavy Machinery, Packaging Equipment, Lifts, Positioning Equipment, Robotics, Linear Control Equipment and more.

So whether controlling rotational motion, or converting rotational to linear motion, or even clockwise to counter clockwise movement, spur gears offer an economical means for controlling, converting and managing motion efficiently and effectively.

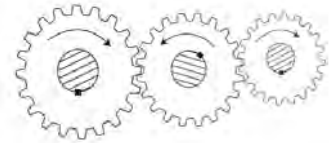

- Line of Centers:** Connects the centers of the pitch circles of two mating gears
- Outside Diameter:** (External gears) The distance from the top of one tooth to the top of a tooth opposite measured through the axis of the gear. $\text{Outside Diameter} = \text{Number of Teeth} + 2 / \text{Diametral Pitch}$.
- Pitch:** The distance between similar, equally spaced tooth surfaces along a given line or curve.
- Pitch Circle:** Circle where mating gear contact occurs. Pitch circles are tangent in mating gears.
- Pitch Diameter:** The diameter of the pitch circle. $\text{Pitch Diameter} = \text{Number of Teeth} / \text{Diametral Pitch}$.
- Point of Contact:** Any point at which two tooth profiles touch each other.
- Pressure Angle:** The angle between a tangent to the tooth profile and a line perpendicular to the pitch surface. Standard gears are either 14-1/2° or 20° degree.
- Root Diameter:** The distance from the bottom of one tooth to the bottom of a tooth opposite measured through the axis of the gear.
- Tooth Thickness:** The thickness of a tooth at the pitch circle.
- Tooth Surface Area:** The contact sides or faces of a gear tooth, or the area including the tooth face and the tooth flank.
- Shaft Angle:** The angle between the axis of two non-parallel gear shafts. This is often referred to as misalignment.
- Spur Gears:** Gears with straight teeth are always parallel to the axis of rotation.

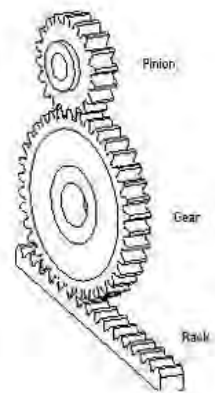



Spur Gear Selection

Formulas & Criteria

The following criteria will provide a guide to gear selection. Steel spur gears in this catalog are from C45 (C1045) material not hardened. Know there can be many factors in selecting the right and exact gear to match expectations, requirements and criteria. There may be many parameters that impact the selection of gears. Below are some of the basic parameters that will begin to help select the right gear. For a loading guide, the rolling stress load on the tooth $\sigma = 589 \text{ N/mm}^2$ and allowable bending stress $\sigma = 200 \text{ N/mm}^2$.

Gear Strength: Choose the spur gear based on gear strength. The permissible bending strength of a gear is referred to as the allowable tangential force at the pitch circle and relates to the allowable load on the tooth and resulting bending stress in the root of the tooth under load.

Surface Durability is the safe force on the tooth without any occurrence of surface failures. Lubrication will be an important consideration for the teeth that mesh to keep working surfaces lubricated. Speed of the gears in mesh will also play a role as will the type of lubrication.

Selection: The next step is to make an estimated selection based on the torque load. Allowable torque for each gear is listed in the catalog pages for each gear. Different manufacturers may use different loading criteria based on service factors and material stress levels. These published Torque ratings are intended as a guide.

Selection Formulas (Metric & Inch Units)

Description	Formula	Dimension (Units)
Number of Teeth	$z = D_p / m$	—
Module	$m = p / \pi = D_p / z$	—
Pitch Diameter	$D_p = z \cdot m$	mm
Tooth Pitch	p	mm
Face Width	h	mm
Addendum Dia.	$D_e = (z + 2) \cdot m$	mm
Pressure Angle	α	degree
Gear Ratio	$r = z_2 / z_1 = n_1 / n_2$	—
Center Distance	$c = (D_{p1} + D_{p2}) / 2 = (z_1 + z_2) \cdot m / 2$	mm
Torque	$T = 9950 \cdot P / n$	Nm
Power	P	kw
Speed	n	rpm
Rim Speed	$v = (Z_1 \cdot m \cdot n_1) / 19100 = \pi \cdot D_e \cdot n / 60,000$	m/sec
Pi	$\pi = 3.1415$	—
E-modulus	$2.1 \cdot 10^5$	N/mm ²
Horsepower	$HP = (T_1 \times n) / 63025$	HP
Torque	T_1	in - lbs
Troque	$T_1 = F \times R$	in - lbs
Radius or moment arm	R	in
Force	F	lbs
Inch		

Linear Motion (Rack & Pinion) Formulas

Acceleration	$a = V / t$	m/sec ²
Time	t	sec
Tangential Acceleration Force (for lifting axis)	$F_T = (m \cdot g) + (m \cdot a)$	lb
Tangential Acceleration Force (for driving axis)	$F_T = (m \cdot g \cdot \mu) + (m \cdot a)$	lb
Coefficient of Friction of axis	μ	—
Mass	m	lb • sec ² / in
Acceleration due to gravity	g	386 in / sec ²

Gear Size is generally proportional to the load capacity. A hardened gear will have more load capacity, but may have less flexibility for absorbing or allowing shock loads or other application requirements. Ground gears will also improve positioning accuracy.

Load or Service Factors for external dynamic loads will also influence the operation and life of the gear. The following service factors that can be applied to the load will help extend service life.

Lubrication: For peripheral speeds less than 0.5 m/s grease will suffice, for peripheral speeds above 0.5 m/s oil should be considered. Safety Factors should be considered for safe working loads.

Speeds: C45 Spur Gears that are milled (un-ground) can be applied at rim speeds up to 12 m/s. As a comparison, ground gears can be applied to 25 m/s. Hardened gears that are milled usually have max limits of 8 m/s due to tooth distortion from the tooth hardening process. Consider multiple stages of gear sets for high reductions.

Noise considerations: milled gears are quietest when held to 5 m/s rim speed. Ground gears would be suggested for more continuous operation primarily for minimizing noise. Also low speed applications, manual drives, pinions with 8-12 teeth can be used. For gears with higher demands, 25 teeth or more should be used.

Note: Metric gear ratings are in metric units. Standard Gear formulas and HP-Torque formulas are to the left and formula conversion factors are given below. Care should be taken to insure unit conversions are accurate.

Service Factors

Drive	Uniform Load Factor	Medium Shock Load Factor	Heavy Shock Load Factor
Uniform	1.0	1.25	1.75
Light Shock	1.25	1.5	2.0
Medium Shock	1.5	1.75	2.25

Conversion Factors:

1 Newton N = 0.2248 lbs
 1 Newton N = 0.102 Kg
 1 Kilogram kg = 2.2 lbs
 1 HP = 0.746 Kikowatt (kw)
 1 meter m = 3.28 Ft = 39.4 inches
 1 inch = 25.4mm

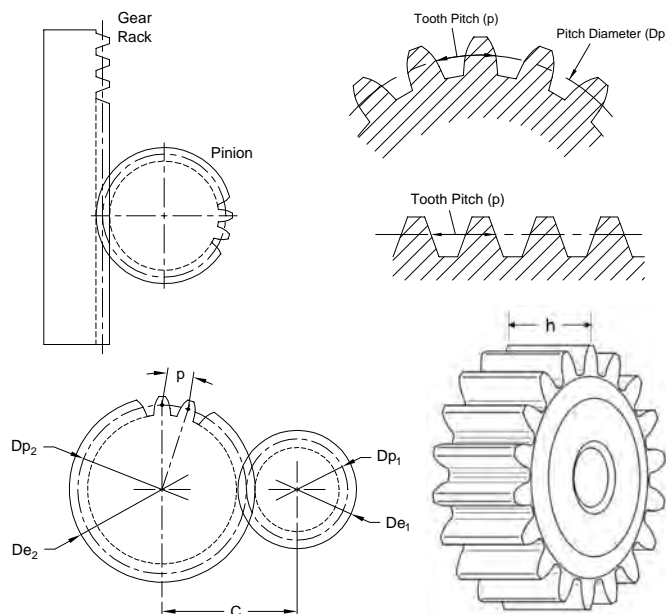

Metric Gear Racks for Spur Gears



Features:

- Tolerance on Single Pitch +/- 20µm
- Tolerance on Sum of Pitches +/- 30µmm on 500mm
- The Quality Grade of the Teeth is from 8 to 9 at DIN 3962/63/67
- 20° Pressure Angle
- Material C 45 E UNI EN 10083-1
- Suitable for Continuous Mounting

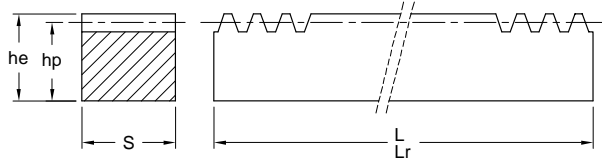

Racks

Module	hp mm	he x S mm	L							
			500 mm		1000 mm		2000 mm		3000 mm	
			Part No.	kg	Part No.	kg	Part No.	kg	Part No.	kg
1	14	15 x 15	M1 x 500	0.82	M1 x 1000	1.50	M1 x 2000	3.10	M1 x 3000	4.90
1.5	15.5	17 x 17	M1.5 x 500	1.00	M1.5 x 1000	2.00	M1.5 x 2000	4.00	M1.5 x 3000	6.10
2	18	20 x 20	M2 x 500	1.40	M2 x 1000	2.70	M2 x 2000	5.40	M2 x 3000	8.40
2.5	22.5	25 x 25	M2.5 x 500	2.10	M2.5 x 1000	4.30	M2.5 x 2000	8.60	M2.5 x 3000	11.90
3	27	30 x 30	M3 x 500	3.10	M3 x 1000	6.30	M3 x 2000	12.50	M3 x 3000	18.60
4 x 25	21	25 x 25	M4 x 25 x 500	1.80	M4 x 25 x 1000	3.65	M4 x 25 x 2000	7.30	M4 x 25 x 3000	10.90
4 x 30	26	30 x 30	M4 x 30 x 500	3.05	M4 x 30 x 1000	6.00	M4 x 30 x 2000	11.90	M4 x 30 x 3000	18.10
4 x 40	36	40 x 40	M4 x 40 x 500	5.50	M4 x 40 x 1000	11.10	M4 x 40 x 2000	22.00	M4 x 40 x 3000	31.30
5	45	50 x 50	M5 x 500	8.30	M5 x 1000	17.50	M5 x 2000	34.60	M5 x 3000	45.30
6	54	60 x 60	M6 x 500	12.65	M6 x 1000	25.00	M6 x 2000	51.00	—	—
8	72	80 x 80	M8 x 500	22.40	M8 x 1000	45.00	M8 x 2000	90.00	—	—

Part No. M2 x 1000

Where: M2 = Module Size
1000 = Length in mm

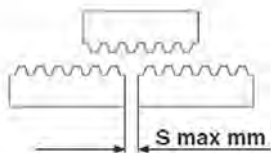

System Mounting

Top Fit Rack
For fit & Alignment

Technical Specification

Module	Pitch mm	S mm	L (Lr = Actual Length)							
			500 mm		1000 mm		2000 mm		3000 mm	
			Teeth	Lr	Teeth	Lr	Teeth	Lr	Teeth	Lr
1	3.1416	0.5	159	499.51	319	1002.17	637	2001.20	955	3000.23
1.5	4.7124	0.6	106	499.51	213	1003.74	425	2002.77	637	3001.80
2	6.2832	0.6	80	502.66	160	1005.31	319	2004.34	478	3003.37
2.5	7.8540	0.7	64	502.66	128	1005.31	255	2002.77	382	3000.23
3	9.4248	0.8	53	499.51	107	1008.45	213	2007.48	319	3006.51
4	12.5664	0.8	40	502.66	80	1005.31	160	2010.62	239	3003.37
5	15.7080	1.0	32	502.66	64	1005.31	128	2010.62	191	3000.23
6	18.8496	1.0	27	508.94	54	1017.88	107	2016.91	—	—
8	25.1328	1.0	20	502.66	40	1005.31	80	2010.62	—	—

Note: Stainless Rack available on request.

Metric Spur Gear



Module 1
20° Pressure Angle
Straight Tooth



Hub Type

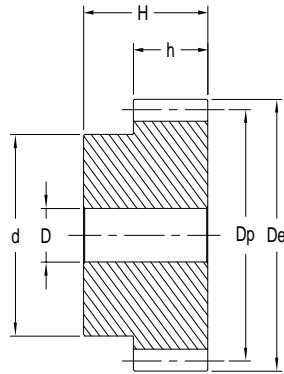
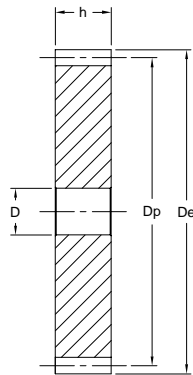

Plate Type



Part No: M1B27

M1 = Module Size

B = Hub Type or A = Plate Type

27 = Number of Teeth

Material: C45 E Steel

Module	h (mm)	H (mm)
1	15	25
1.5	17	30
2	20	35
2.5	25	40
3	30	50
4	40	60
5	50	75
6	60	80
8	65	95

Note: Finished bores on request. All Dimensions in mm. Torque Ratings based on Permissible Fatigue Strength and Flank Pressure.

Teeth	Module 1							
	Part No.		De mm	Dp mm	d mm	D mm	Max Torque Ncm	Wt g
	Hub Type	Plate Type						
12	M1B12	—	14	12	9	5	35	10
13	M1B13	—	15	13	10	5	40	20
14	M1B14	—	16	14	10	5	45	20
15	M1B15	—	17	15	12	6	49	20
16	M1B16	—	18	16	13	6	53	30
17	M1B17	—	19	17	14	8	55	30
18	M1B18	—	20	18	15	8	62	30
19	M1B19	—	21	19	15	8	72	40
20	M1B20	—	22	20	16	8	81	40
21	M1B21	—	23	21	16	8	91	50
22	M1B22	—	24	22	18	8	101	50
23	M1B23	—	25	23	18	8	112	60
24	M1B24	—	26	24	20	8	125	60
25	M1B25	—	27	25	20	8	136	70
26	M1B26	—	28	26	20	8	150	70
27	M1B27	—	29	27	20	8	164	80
28	M1B28	—	30	28	20	8	177	80
29	M1B29	—	31	29	20	8	195	90
30	M1B30	—	32	30	20	8	209	90
31	M1B31	—	33	31	25	10	224	110
32	M1B32	—	34	32	25	10	243	120
33	M1B33	—	35	33	25	10	262	120
34	M1B34	—	36	34	25	10	279	130
35	M1B35	—	37	35	25	10	299	140
36	M1B36	—	38	36	25	10	318	140
37	M1B37	—	39	37	25	10	329	150
38	M1B38	—	40	38	25	10	364	160
39	M1B39	—	41	39	25	10	385	160
40	M1B40	—	42	40	25	10	409	170
41	M1B41	—	43	41	30	10	436	190
42	M1B42	—	44	42	30	10	459	200
43	M1B43	—	45	43	30	10	486	210
44	M1B44	—	46	44	30	10	511	220
45	M1B45	—	47	45	30	10	538	230
46	M1B46	—	48	46	30	10	566	230
47	M1B47	—	49	47	30	10	602	240
48	M1B48	—	50	48	30	10	642	250
49	M1B49	—	51	49	30	10	682	260
50	M1B50	—	52	50	30	12	725	260
51	M1B51	—	53	51	40	12	769	320
52	M1B52	—	54	52	40	12	818	330
53	M1B53	—	55	53	40	12	843	330
54	M1B54	—	56	54	40	12	893	340
55	M1B55	—	57	55	40	12	934	360
56	M1B56	—	58	56	40	12	972	370
57	M1B57	—	59	57	40	12	1013	380
58	M1B58	—	60	58	40	12	1054	390
59	M1B59	—	61	59	40	12	1101	400
60	M1B60	M1A60	62	60	40	12	1146	410
61	M1B61	—	63	61	50	12	1196	470
62	M1B62	—	64	62	50	12	1265	490
63	M1B63	—	65	63	50	12	1330	500
64	M1B64	—	66	64	50	12	1395	510
65	M1B65	—	67	65	50	12	1459	520
66	M1B66	—	68	66	50	12	1503	530
67	M1B67	—	69	67	50	12	1548	550
68	M1B68	—	70	68	50	12	1592	560
69	M1B69	—	71	69	50	12	1630	570
70	M1B70	M1A70	72	70	50	12	1665	580
72	M1B72	M1A72	74	72	50	12	1729	650
75	M1B75	M1A75	77	75	50	12	1838	730
76	M1B76	M1A76	78	76	50	12	1872	750
80	M1B80	M1A80	82	80	50	12	2030	800
85	—	M1A85	87	85	—	12	2230	730
90	M1B90	M1A90	92	90	50	12	2450	850
95	—	M1A95	97	95	—	12	2660	820
100	M1B100	M1A100	102	100	60	12	2890	900
110	—	M1A110	112	110	—	12	3710	910
114	—	M1A114	116	114	—	12	3820	1000
120	—	M1A120	122	120	—	12	4000	1320
127	—	M1A127	129	127	—	12	4200	1470

Metric Spur Gear with Hub

Module 1.5
20° Pressure Angle
Straight Tooth



Hub Type

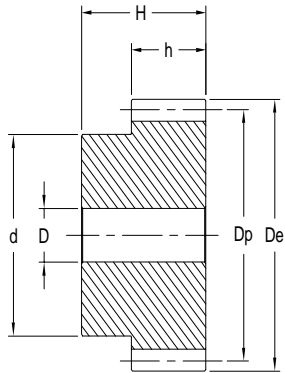
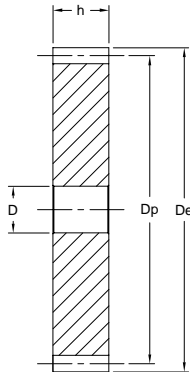

Plate Type



Part No: M1.5B27

M1.5 = Module Size

B = Hub Type or A = Plate Type

27 = Number of Teeth

Material: C45 E Steel

Module	h (mm)	H (mm)
1	15	25
1.5	17	30
2	20	35
2.5	25	40
3	30	50
4	40	60
5	50	75
6	60	80
8	65	95

Note: Finished bores on request. All Dimensions in mm. Torque Ratings based on Permissible Fatigue Strength and Flank Pressure.

Teeth	Module 1.5							
	Part No.		De mm	Dp mm	d mm	D mm	Max Torque Ncm	Wt. kg
	Hub Type	Plate type						
12	M1.5B12	—	21.0	18.0	14	8	114	40
13	M1.5B13	—	22.5	19.5	14	8	130	50
14	M1.5B14	—	24.0	21.0	18	8	146	60
15	M1.5B15	—	25.5	22.5	18	8	158	70
16	M1.5B16	—	27.0	24.0	20	8	171	80
17	M1.5B17	—	28.5	25.5	20	8	179	90
18	M1.5B18	—	30.0	27.0	20	8	199	100
19	M1.5B19	—	31.5	28.5	20	8	231	100
20	M1.5B20	—	33.0	30.0	25	8	260	130
21	M1.5B21	—	34.5	31.5	25	10	292	130
22	M1.5B22	—	36.0	33.0	25	10	325	140
23	M1.5B23	—	37.5	34.5	25	10	361	160
24	M1.5B24	—	39.0	36.0	25	10	402	170
25	M1.5B25	—	40.5	37.5	25	10	438	180
26	M1.5B26	—	42.0	39.0	30	12	483	200
27	M1.5B27	—	43.5	40.5	30	12	528	220
28	M1.5B28	—	45.0	42.0	30	12	572	230
29	M1.5B29	—	46.5	43.5	30	12	629	240
30	M1.5B30	—	48.0	45.0	30	12	674	260
31	M1.5B31	—	49.5	46.5	35	12	723	300
32	M1.5B32	—	51.0	48.0	35	12	784	310
33	M1.5B33	—	52.5	49.5	35	12	844	330
34	M1.5B34	—	54.0	51.0	35	12	901	340
35	M1.5B35	—	55.5	52.5	35	12	966	360
36	M1.5B36	—	57.0	54.0	35	12	1027	370
37	M1.5B37	—	58.5	55.5	40	12	1060	420
38	M1.5B38	—	60.0	57.0	40	12	1173	440
39	M1.5B39	—	61.5	58.5	40	12	1242	460
40	M1.5B40	—	63.0	60.0	40	12	1320	480
41	M1.5B41	—	64.5	61.5	50	14	1405	500
42	M1.5B42	—	66.0	63.0	50	14	1482	590
43	M1.5B43	—	67.5	64.5	50	14	1567	610
44	M1.5B44	—	69.0	66.0	50	14	1648	630
45	M1.5B45	—	70.5	67.5	50	14	1734	650
46	M1.5B46	—	72.0	69.0	50	14	1827	660
47	M1.5B47	—	73.5	70.5	50	14	1941	700
48	M1.5B48	—	75.0	72.0	50	14	2071	700
49	M1.5B49	—	76.5	73.5	50	14	2200	730
50	M1.5B50	—	78.0	75.0	50	14	2339	760
51	M1.5B51	—	79.5	76.5	60	15	2480	860
52	M1.5B52	—	81.0	78.0	60	15	2640	890
53	M1.5B53	—	82.5	79.5	60	15	2720	910
54	M1.5B54	—	84.0	81.0	60	15	2882	940
55	M1.5B55	—	85.5	82.5	60	15	3014	960
56	M1.5B56	—	87.0	84.0	60	15	3135	980
57	M1.5B57	—	88.5	85.5	60	15	3267	1000
58	M1.5B58	—	90.0	87.0	60	15	3399	1030
59	M1.5B59	—	91.5	88.5	60	15	3551	1060
60	M1.5B60	—	93.0	90.0	60	15	3696	1090
61	M1.5B61	—	94.5	91.5	70	20	3858	1220
62	M1.5B62	—	96.0	93.0	70	20	4081	1250
63	M1.5B63	—	97.5	94.5	70	20	4290	1280
64	M1.5B64	—	99.0	96.0	70	20	4499	1310
65	M1.5B65	—	100.5	97.5	70	20	4708	1340
66	M1.5B66	—	102.0	99.0	70	20	4848	1370
67	M1.5B67	—	103.5	100.5	70	20	4993	1400
68	M1.5B68	—	105.0	102.0	70	20	5137	1430
69	M1.5B69	—	106.5	103.5	70	20	5257	1460
70	M1.5B70	—	108.0	105.0	70	20	5370	1500
72	M1.5B72	M1.5A72	111.0	108.0	80	20	5577	1190
75	—	M1.5A75	115.5	112.5	—	20	5929	1300
76	—	M1.5A76	117.0	114.0	—	20	6039	1330
80	—	M1.5A80	123.0	120.0	—	20	6512	1480
85	—	M1.5A85	130.5	127.5	—	20	8063	1670
90	—	M1.5A90	138.0	135.0	—	20	8481	1880
95	—	M1.5A95	145.5	142.5	—	20	8888	2090
100	—	M1.5A100	153.0	150.0	—	20	9218	2320
110	—	M1.5A110	168.0	165.0	—	20	9416	2820
114	—	M1.5A114	174.0	171.0	—	20	9620	3030
120	—	M1.5A120	183.0	180.0	—	20	10076	3360
127	—	M1.5A127	193.5	190.5	—	20	10705	3770



Metric Spur Gear with Hub

Module 2
20° Pressure Angle
Straight Tooth



Hub Type

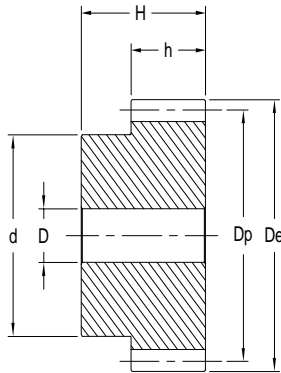
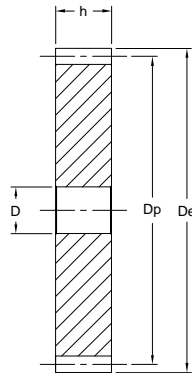

Plate Type



Part No: M2B27

M2 = Module Size

B = Hub Type or A = Plate Type

27 = Number of Teeth

Material: C45 E Steel

Module	h (mm)	H (mm)
1	15	25
1.5	17	30
2	20	35
2.5	25	40
3	30	50
4	40	60
5	50	75
6	60	80
8	65	95

Note: Finished bores on request. All Dimensions in mm. Torque Ratings based on Permissible Fatigue Strength and Flank Pressure.

Teeth	Module 2							
	Part No.		De mm	Dp mm	d mm	D mm	Max Torque Nm	Wt. g
	Hub Type	Plate Type						
12	M2B12	—	28	24	18	10	2.8	80
13	M2B13	—	30	26	19	10	3.2	100
14	M2B14	—	32	28	20	10	3.6	120
15	M2B15	—	34	30	22	10	3.9	140
16	M2B16	—	36	32	24	10	4.2	160
17	M2B17	—	38	34	25	10	4.4	180
18	M2B18	—	40	36	25	10	4.9	190
19	M2B19	—	42	38	25	10	5.7	210
20	M2B20	—	44	40	30	10	6.4	260
21	M2B21	—	46	42	30	10	7.2	270
22	M2B22	—	48	44	30	12	8.0	290
23	M2B23	—	50	46	30	12	8.9	310
24	M2B24	—	52	48	35	12	9.9	360
25	M2B25	—	54	50	35	12	10.8	390
26	M2B26	—	56	52	40	12	11.9	450
27	M2B27	—	58	54	40	12	13.0	470
28	M2B28	—	60	56	40	12	14.1	500
29	M2B29	—	62	58	40	14	15.5	520
30	M2B30	—	64	60	40	14	16.6	550
31	M2B31	—	66	62	45	14	17.8	610
32	M2B32	—	68	64	45	14	19.3	650
33	M2B33	—	70	66	45	14	20.8	680
34	M2B34	—	72	68	45	14	22.2	710
35	M2B35	—	74	70	45	14	23.8	740
36	M2B36	—	76	72	45	14	25.3	780
37	M2B37	—	78	74	50	14	26.1	860
38	M2B38	—	80	76	50	14	28.9	900
39	M2B39	—	82	78	50	14	30.6	930
40	M2B40	—	84	80	50	14	32.5	970
41	M2B41	—	86	82	60	16	34.6	1050
42	M2B42	—	88	84	60	16	36.5	1090
43	M2B43	—	90	86	60	16	38.6	1130
44	M2B44	—	92	88	60	16	40.6	1230
45	M2B45	—	94	90	60	16	42.7	1270
46	M2B46	—	96	92	60	16	45.0	1310
47	M2B47	—	98	94	70	16	47.8	1480
48	M2B48	—	100	96	70	16	51.0	1530
49	M2B49	—	102	98	70	16	54.2	1570
50	M2B50	—	104	100	70	16	57.6	1620
51	M2B51	—	106	102	70	20	61.1	1670
52	M2B52	—	108	104	70	20	64.8	1720
53	M2B53	—	110	106	70	20	68.5	1780
54	M2B54	—	112	108	70	20	72.4	1830
55	M2B55	—	114	110	70	20	76.3	1880
56	M2B56	—	116	112	70	20	80.5	1940
57	M2B57	—	118	114	70	20	84.7	1990
58	M2B58	—	120	116	70	20	89.0	2050
59	M2B59	—	122	118	70	20	93.1	2110
60	M2B60	—	124	120	70	20	97.3	2160
61	M2B61	—	126	122	80	20	102.0	2360
62	M2B62	—	128	124	80	20	107.0	2420
63	M2B63	—	130	126	80	20	111.0	2480
64	M2B64	—	132	128	80	20	114.0	2550
65	M2B65	—	134	130	80	20	117.0	2610
66	M2B66	—	136	132	80	20	120.0	2670
67	M2B67	—	138	134	80	20	122.0	2740
68	M2B68	—	140	136	80	20	125.0	2810
69	M2B69	—	142	138	80	20	127.0	2870
70	M2B70	—	144	140	80	20	130.0	2940
72	M2B72	M2A72	148	144	80	20	135.0	2500
75	—	M2A75	148	144	—	20	166.0	2710
76	—	M2A76	154	150	—	20	168.0	2790
80	—	M2A80	156	152	—	20	175.0	3090
85	—	M2A85	164	160	—	20	179.0	3500
90	—	M2A90	174	170	—	20	180.0	3930
95	—	M2A95	184	180	—	20	181.0	4390
100	—	M2A100	194	190	—	20	185.0	4870
110	—	M2A110	204	200	—	20	201.0	5900
114	—	M2A114	224	220	—	20	208.0	6340
120	—	M2A120	232	228	—	20	217.0	7030
127	—	M2A127	244	240	—	20	235.0	7890



Metric Spur Gear with Hub

Module 2.5
20° Pressure Angle
Straight Tooth



Hub Type

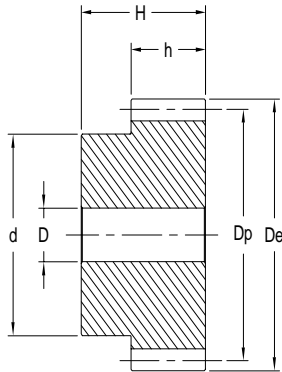
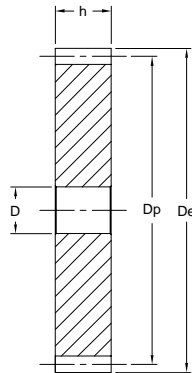

Plate Type



Part No: M2.5B27

M2.5 = Module Size

B = Hub Type or A = Plate Type

27 = Number of Teeth

Material: C45 E Steel

Module	h (mm)	H (mm)
1	15	25
1.5	17	30
2	20	35
2.5	25	40
3	30	50
4	40	60
5	50	75
6	60	80
8	65	95

Note: Finished bores on request. All Dimensions in mm. Torque Ratings based on Permissible Fatigue Strength and Flank Pressure.

Teeth	Module 2.5							
	Part No.		De mm	Dp mm	d mm	D mm	Max Torque Nm	Wt. kg
	Hub Type	Plate Type						
12	M2.5B12	—	35.0	30.0	22	10	5.9	0.17
13	M2.5B13	—	37.5	32.5	25	10	6.7	0.21
14	M2.5B14	—	40.0	35.0	28	10	7.6	0.25
15	M2.5B15	—	42.5	37.5	30	10	8.3	0.30
16	M2.5B16	—	45.0	40.0	32	12	8.9	0.33
17	M2.5B17	—	47.5	42.5	35	12	9.2	0.38
18	M2.5B18	—	50.0	45.0	35	12	10.4	0.42
19	M2.5B19	—	52.5	47.5	35	12	11.9	0.45
20	M2.5B20	—	55.0	50.0	40	14	13.4	0.54
21	M2.5B21	—	57.5	52.5	40	14	15.1	0.56
22	M2.5B22	—	60.0	55.0	45	14	16.9	0.66
23	M2.5B23	—	62.5	57.5	45	14	18.7	0.70
24	M2.5B24	—	65.0	60.0	45	14	20.8	0.74
25	M2.5B25	—	67.5	62.5	50	14	22.8	0.85
26	M2.5B26	—	70.0	65.0	50	14	25.0	0.90
27	M2.5B27	—	72.5	67.5	50	14	27.3	0.95
28	M2.5B28	—	75.0	70.0	50	14	29.6	1.00
29	M2.5B29	—	77.5	72.5	50	14	32.7	1.06
30	M2.5B30	—	80.0	75.0	55	16	34.9	1.18
31	M2.5B31	—	82.5	77.5	55	16	37.5	1.22
32	M2.5B32	—	85.0	80.0	55	16	40.6	1.28
33	M2.5B33	—	87.5	82.5	55	16	43.8	1.34
34	M2.5B34	—	90.0	85.0	55	16	46.7	1.41
35	M2.5B35	—	92.5	87.5	60	16	50.2	1.54
36	M2.5B36	—	95.0	90.0	60	16	53.3	1.61
37	M2.5B37	—	97.5	92.5	60	16	54.9	1.68
38	M2.5B38	—	100.0	95.0	60	16	60.8	1.75
39	M2.5B39	—	102.5	97.5	60	16	65.3	1.83
40	M2.5B40	—	105.0	100.0	70	20	71.2	2.06
41	M2.5B41	—	107.5	102.5	70	20	77.4	2.14
42	M2.5B42	—	110.0	105.0	70	20	82.2	2.22
43	M2.5B43	—	112.5	107.5	70	20	92.4	2.30
44	M2.5B44	—	115.0	110.0	70	20	96.6	2.38
45	M2.5B45	—	117.5	112.5	70	20	100.0	2.47
46	M2.5B46	—	120.0	115.0	70	20	107.0	2.52
47	M2.5B47	—	122.5	117.5	80	20	114.0	2.80
48	M2.5B48	—	125.0	120.0	80	20	120.0	2.88
49	M2.5B49	—	127.5	122.5	80	20	128.0	2.98
50	M2.5B50	—	130.0	125.0	80	20	135.0	3.07
51	M2.5B51	—	132.5	127.5	80	20	143.0	3.17
52	M2.5B52	—	135.0	130.0	90	20	149.0	3.48
53	M2.5B53	—	137.5	132.5	90	20	156.0	3.58
54	M2.5B54	—	140.0	135.0	90	20	165.0	3.68
55	M2.5B55	—	142.5	137.5	90	20	173.0	3.78
56	M2.5B56	—	145.0	140.0	100	20	181.0	4.13
57	M2.5B57	—	147.5	142.5	100	20	190.0	4.23
58	M2.5B58	—	150.0	145.0	100	20	199.0	4.34
59	M2.5B59	—	152.5	147.5	100	20	208.0	4.46
60	M2.5B60	—	155.0	150.0	100	20	217.0	4.57
62	M2.5B62	—	160.0	155.0	100	20	240.0	4.59
63	M2.5B63	—	162.5	157.5	100	20	260.0	4.60
65	M2.5B65	M2.5A65	167.5	162.5	100	20	286.0	3.99
67	M2.5B67	—	172.5	167.5	100	20	295.0	4.61
70	M2.5B70	M2.5A70	180.0	175.0	100	20	324.0	4.64
72	—	M2.5A72	185.0	180.0	—	20	332.0	4.91
75	—	M2.5A75	192.5	187.5	—	20	338.0	5.33
76	—	M2.5A76	195.0	190.0	—	20	340.0	5.48
80	—	M2.5A80	205.0	200.0	—	25	342.0	6.04
85	—	M2.5A85	217.5	212.5	—	25	346.0	6.84
90	—	M2.5A90	230.0	225.0	—	25	348.0	7.68
95	—	M2.5A95	242.5	237.5	—	25	361.0	8.57
100	—	M2.5A100	255.0	250.0	—	25	378.0	9.51
110	—	M2.5A110	280.0	275.0	—	25	408.0	11.53
114	—	M2.5A114	290.0	285.0	—	25	419.0	12.39
120	—	M2.5A120	305.0	300.0	—	25	438.0	13.74
127	—	M2.5A127	322.2	317.5	—	25	453.0	15.40



Metric Spur Gear with Hub

Module 3
20° Pressure Angle
Straight Tooth



Hub Type

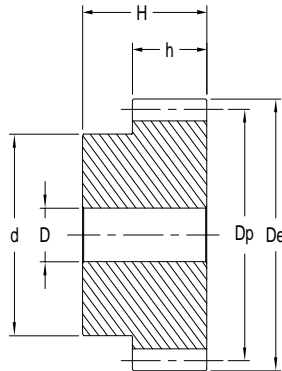
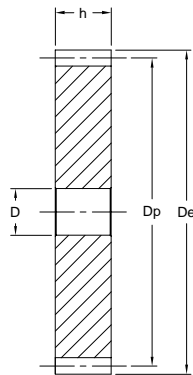

Plate Type



Part No: M3B27

M3 = Module Size

B = Hub Type or A = Plate Type

27 = Number of Teeth

Material: C45 E Steel

Module	h (mm)	H (mm)
1	15	25
1.5	17	30
2	20	35
2.5	25	40
3	30	50
4	40	60
5	50	75
6	60	80
8	65	95

Note: Finished bores on request. All Dimensions in mm.
 Torque Ratings based on Permissible Fatigue Strength and Flank Pressure.

Teeth	Module 3							
	Part No.		De mm	Dp mm	d mm	D mm	Max Torque Nm	Wt. Kg
	Hub Type	Plate Type						
12	M3B12	—	42	36	25	12	10.7	0.28
13	M3B13	—	45	39	25	12	12.1	0.34
14	M3B14	—	48	42	30	12	13.6	0.41
15	M3B15	—	51	45	35	12	15.0	0.47
16	M3B16	—	54	48	38	15	16.1	0.54
17	M3B17	—	57	51	42	15	17.0	0.63
18	M3B18	—	60	54	45	15	19.0	0.72
19	M3B19	—	63	57	45	15	21.6	0.78
20	M3B20	—	66	60	45	15	24.5	0.84
21	M3B21	—	69	63	45	15	27.5	0.89
22	M3B22	—	72	66	50	15	30.7	1.02
23	M3B23	—	75	69	50	15	34.0	1.10
24	M3B24	—	78	72	50	16	37.6	1.18
25	M3B25	—	81	75	60	16	41.4	1.39
26	M3B26	—	84	78	60	16	45.4	1.48
27	M3B27	—	87	81	60	16	49.7	1.56
28	M3B28	—	90	84	60	16	54.1	1.66
29	M3B29	—	93	87	60	16	59.2	1.75
30	M3B30	—	96	90	60	16	63.5	1.85
31	M3B31	—	99	93	70	20	69.2	1.95
32	M3B32	—	102	96	70	20	74.6	2.21
33	M3B33	—	105	99	70	20	82.8	2.32
34	M3B34	—	108	102	70	20	88.6	2.43
35	M3B35	—	111	105	70	20	97.8	2.55
36	M3B36	—	114	108	70	20	106.0	2.62
37	M3B37	—	117	111	80	20	115.0	2.74
38	M3B38	—	120	114	80	20	124.0	3.05
39	M3B39	—	123	117	80	20	135.0	3.18
40	M3B40	—	126	120	80	20	143.0	3.31
41	M3B41	—	129	123	90	20	155.0	3.44
42	M3B42	—	132	126	90	20	164.0	3.58
43	M3B43	—	135	129	90	20	175.0	3.72
44	M3B44	—	138	132	90	20	186.0	4.07
45	M3B45	—	141	135	90	20	196.0	4.22
46	M3B46	—	144	138	90	20	207.0	4.37
47	M3B47	—	147	141	90	20	220.0	4.76
48	M3B48	M3A48	150	144	100	20	232.0	4.92
49	M3B49	—	153	147	100	20	240.0	5.10
50	M3B50	M3A50	156	150	100	20	258.0	5.20
52	—	M3A52	162	156	100	25	286.0	4.40
54	M3B54	—	168	162	100	20	310.0	5.25
55	M3B55	M3A55	171	165	100	20	331.0	5.60
56	M3B56	—	174	168	100	20	348.0	6.10
57	M3B57	M3A57	177	171	100	20	364.0	6.30
60	M3B60	M3A60	186	180	100	20	437.0	6.75
62	M3B62	—	192	186	100	20	480.0	7.50
65	M3B65	M3A65	201	195	100	20	531.0	6.92
70	—	M3A70	216	210	—	25	552.0	8.00
72	—	M3A72	222	216	—	25	554.0	8.47
75	—	M3A75	231	225	—	25	557.0	9.21
76	—	M3A76	234	228	—	25	559.0	9.46
80	—	M3A80	246	240	—	25	564.0	10.49
85	—	M3A85	261	255	—	25	580.0	11.86
90	—	M3A90	276	270	—	25	610.0	13.32
95	—	M3A95	291	285	—	25	640.0	14.86
100	—	M3A100	306	300	—	25	667.0	16.48
110	—	M3A110	336	330	—	25	705.0	19.97
114	—	M3A114	348	342	—	30	740.0	21.40
120	—	M3A120	366	360	—	30	774.0	23.74
127	—	M3A127	387	381	—	30	800.0	26.61



Metric Spur Gear with Hub

Module 4
20° Pressure Angle
Straight Tooth



Hub Type

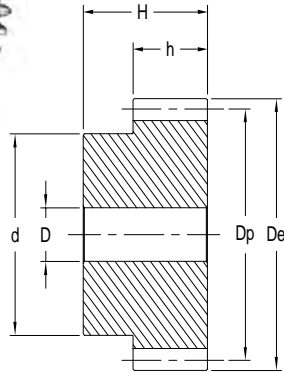
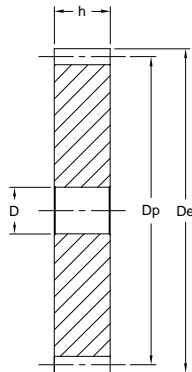

Plate Type



Part No: M4B27

M4 = Module Size

B = Hub Type or A = Plate Type

27 = Number of Teeth

Material: C45 E Steel

Module	h (mm)	H (mm)
1	15	25
1.5	17	30
2	20	35
2.5	25	40
3	30	50
4	40	60
5	50	75
6	60	80
8	65	95

Teeth	Module 4							Max Torque Nm	Wt. kg
	Part No.		De mm	Dp mm	d mm	D mm			
	Hub Type	Plate Type							
12	M4B12	—	56	48	35	14	26	0.63	
13	M4B13	—	60	52	40	14	30	0.78	
14	M4B14	—	64	56	45	14	34	0.93	
15	M4B15	—	68	60	45	14	38	1.05	
16	M4B16	—	72	64	50	15	40	1.20	
17	M4B17	—	76	68	50	15	43	1.33	
18	M4B18	—	80	72	50	15	48	1.47	
19	M4B19	—	84	76	60	15	54	1.75	
20	M4B20	—	88	80	60	15	61	1.90	
21	M4B21	—	92	84	70	20	69	2.22	
22	M4B22	—	96	88	70	20	78	2.39	
23	M4B23	—	100	92	75	20	86	2.60	
24	M4B24	—	104	96	75	20	95	2.79	
25	M4B25	—	108	100	75	20	109	2.98	
26	M4B26	—	112	104	75	20	121	3.18	
27	M4B27	—	116	108	75	20	136	3.39	
28	M4B28	—	120	112	75	20	153	3.60	
29	M4B29	—	124	116	75	20	171	3.83	
30	M4B30	—	128	120	75	20	185	4.06	
31	M4B31	—	132	124	80	20	205	4.39	
32	M4B32	—	136	128	80	20	220	4.64	
33	M4B33	—	140	132	80	20	248	4.90	
34	M4B34	—	144	136	80	20	264	5.16	
35	M4B35	—	148	140	80	20	278	5.43	
36	M4B36	—	152	144	80	20	299	5.63	
37	M4B37	—	156	148	80	20	320	5.80	
38	M4B38	M4A38	160	152	80	25	344	5.85	
39	M4B39	—	164	156	80	25	370	5.90	
40	M4B40	M4A40	168	160	80	25	394	6.11	
45	M4B45	M4A45	188	180	80	25	536	7.78	
48	M4B48	M4A48	200	192	80	25	638	8.87	
50	M4B50	M4A50	208	200	80	25	710	9.65	
52	—	M4A52	216	208	—	25	795	10.45	
55	—	M4A55	228	220	—	25	913	11.71	
57	—	M4A57	236	228	—	25	1020	12.59	
60	M4B60	M4A60	248	240	100	25	1131	13.97	
65	M4B65	M4A65	268	260	100	25	1220	16.43	
70	—	M4A70	288	280	—	25	1231	19.09	
75	—	M4A75	308	300	—	25	1288	21.94	
76	—	M4A76	312	304	—	25	1303	22.47	
80	—	M4A80	328	320	—	25	1354	24.93	
85	—	M4A85	348	340	—	25	1430	28.18	
90	—	M4A90	368	360	—	25	1500	31.62	
95	—	M4A95	388	380	—	25	1580	35.26	
100	—	M4A100	408	400	—	25	1650	39.11	
110	—	M4A110	448	440	—	25	1744	47.38	
114	—	M4A114	464	456	—	25	1830	50.91	

Note: Finished bores on request. All Dimensions in mm.
 Torque Ratings based on Permissible Fatigue Strength and Flank Pressure.

Metric Spur Gear with Hub



Module 5
20° Pressure Angle
Straight Tooth



Hub Type

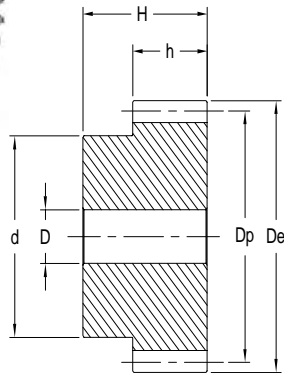
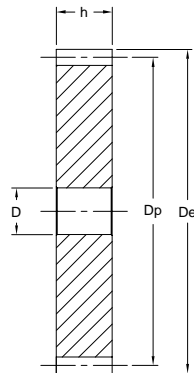

Plate Type



Part No: M5B27

M5 = Module Size

B = Hub Type or A = Plate Type

27 = Number of Teeth

Material: C45 E Steel

Module	h (mm)	H (mm)
1	15	25
1.5	17	30
2	20	35
2.5	25	40
3	30	50
4	40	60
5	50	75
6	60	80
8	65	95

Teeth	Module 5							
	Part No.		De mm	Dp mm	d mm	D mm	Max Torque Nm	Wt. kg
	Hub Type	Plate Type						
12	M5B12	—	70	60	45	16	58	1.21
13	M5B13	—	75	65	50	16	64	1.47
14	M5B14	—	80	70	55	20	71	1.76
15	M5B15	—	85	75	60	20	79	2.07
16	M5B16	—	90	80	65	20	86	2.40
17	M5B17	—	95	85	70	20	88	2.75
18	M5B18	—	100	90	70	20	100	3.02
19	M5B19	—	105	95	70	20	115	3.30
20	M5B20	—	110	100	80	20	134	3.83
21	M5B21	—	115	105	80	20	157	4.15
22	M5B22	—	120	110	80	25	181	4.48
23	M5B23	—	125	115	90	25	206	5.08
24	M5B24	—	130	120	90	25	232	5.44
25	M5B25	—	135	125	90	25	261	5.82
26	M5B26	—	140	130	100	25	288	6.50
27	M5B27	—	145	135	100	25	318	6.91
28	M5B28	—	150	140	100	25	349	7.22
29	M5B29	—	155	145	100	25	385	7.98
30	M5B30	—	160	150	100	25	418	8.44
32	M5B32	M5A32	170	160	110	25	495	7.62
35	—	M5A35	185	175	—	25	626	9.16
36	M5B36	—	190	180	110	25	700	10.00
38	M5B38	M5A38	200	190	110	30	781	10.84
40	M5B40	M5A40	210	200	110	30	893	12.04
42	M5B42	—	220	210	120	25	1050	14.00
45	—	M5A45	235	225	—	30	1202	15.30
48	—	M5A48	250	240	—	30	1411	17.44
50	—	M5A50	260	250	—	30	1561	18.86
52	—	M5A52	270	260	—	30	1721	20.43
55	M5B55	M5A55	285	275	120	30	1978	22.89
57	—	M5A57	295	285	—	30	2030	24.62
60	M5B60	M5A60	310	300	120	30	2202	27.31
65	—	M5A65	335	325	—	30	2324	32.12
70	—	M5A70	360	350	—	30	2482	37.31
75	—	M5A75	385	375	—	30	2576	42.88
76	—	M5A76	390	380	—	30	2606	44.04
80	—	M5A80	410	400	—	30	2708	48.84
85	—	M5A85	435	425	—	30	2860	55.19
90	—	M5A90	460	450	—	30	3000	61.92
95	—	M5A95	485	475	—	30	3160	69.03
100	—	M5A100	510	500	—	30	3300	76.53
110	—	M5A110	560	550	—	30	3450	92.69
114	—	M5A114	580	570	—	30	3600	99.59

Note: Finished bores on request. All Dimensions in mm. Torque Ratings based on Permissible Fatigue Strength and Flank Pressure.

Metric Spur Gear with Hub



Module 6 & 8
20° Pressure Angle
Straight Tooth

Plate Type

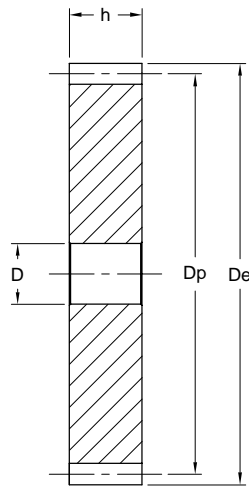

Hub Type

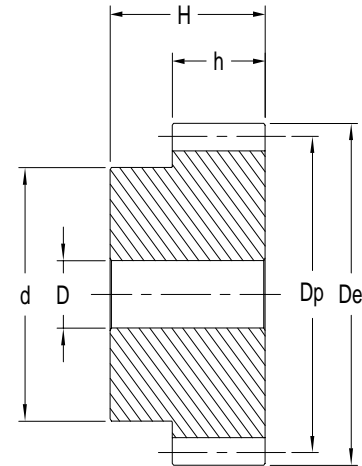

Part No: M6B20

M6 = Module Size

B = Hub Type or A = Plate Type

20 = Number of Teeth

Material: C45 E Steel

Module	h (mm)	H (mm)
1	15	25
1.5	17	30
2	20	35
2.5	25	40
3	30	50
4	40	60
5	50	75
6	60	80
8	65	95

Teeth	Module 6							
	Part No.		De mm	Dp mm	d mm	D	Max Torque Nm	Wt. kg
	Hub Type	Plate Type						
12	M6B12	—	84	72	54	20	110	1.82
14	M6B14	—	96	84	65	20	129	2.20
15	M6B15	—	102	90	70	20	161	3.01
16	M6B16	—	108	96	75	20	167	3.46
18	M6B18	—	120	108	80	20	201	4.33
20	M6B20	—	132	120	90	20	277	5.43
23	M6B23	—	150	138	110	25	310	6.00
24	M6B24	—	156	144	110	25	450	7.88
25	M6B25	—	162	150	110	25	500	8.42
30	M6B30	M6A30	192	180	110	25	808	9.69
32	—	M6A32	204	192	—	25	960	11.05
38	—	M6A38	240	220	—	25	1470	15.69
40	M6B40	M6A40	252	240	120	25	1680	17.42

Part No: M8B20

M8 = Module Size

B = Hub Type

20 = Number of Teeth

Material: C45 E Steel

Teeth	Module 8						
	Part No. Hub Type	De mm	Dp mm	d mm	D	Max Torque Nm	Wt. kg
12	M8B12	96	112	70	25	240	4.2
15	M8B15	120	136	80	25	370	6.5
18	M8B18	144	160	80	25	495	9.0
20	M8B20	160	176	100	30	655	11.5
24	M8B24	192	208	120	30	1045	16.9
25	M8B25	200	216	120	30	1160	18.1
30	M8B30	240	256	150	30	1834	26.6
36	M8B36	288	304	160	40	2900	36.9
40	M8B40**	320	336	180	40	3790	46.0

Note: Finished bores on request. All Dimensions in mm. Torque Ratings based on Permissible Fatigue Strength and Flank Pressure.

Note: ** Welded Hub